

SONY[®]

4-296-526-11 (1)

Video Projector

<http://www.sony.net/>

Printed on recycled paper.

Sony Corporation Printed in Japan

Operating Instructions

VPL-VW95ES

SXRD **HDMI**
Silicon X-tal Reflective Display

— © 2011 Sony Corporation



4296526110

WARNING

To reduce the risk of fire or electric shock, do not expose this apparatus to rain or moisture.

To avoid electrical shock, do not open the cabinet. Refer servicing to qualified personnel only.

THIS APPARATUS MUST BE EARTHED.

For the customers in the U.S.A. and Canada

WARNING:

Using this unit at a voltage other than 120 V may require the use of a different line cord or attachment plug, or both. To reduce the risk of fire or electric shock, refer servicing to qualified service personnel.

For the customers in the U.S.A.

This equipment has been tested and found to comply with the limits for a Class B digital device, pursuant to Part 15 of the FCC Rules. These limits are designed to provide reasonable protection against harmful interference in a residential installation. This equipment generates, uses, and can radiate radio frequency energy and, if not installed and used in accordance with the instructions, may cause harmful interference to radio communications. However, there is no guarantee that interference will not occur in a particular installation. If this equipment does cause harmful interference to radio or television reception, which can be determined by turning the equipment off and on, the user is encouraged to try to correct the interference by one or more of the following measures:

- Reorient or relocate the receiving antenna.
- Increase the separation between the equipment and receiver.

- Connect the equipment into an outlet on a circuit different from that to which the receiver is connected.
- Consult the dealer or an experienced radio/TV technician for help.

You are cautioned that any changes or modifications not expressly approved in this manual could void your authority to operate this equipment.

All interface cables used to connect peripherals must be shielded in order to comply with the limits for a digital device pursuant to Subpart B of Part 15 of FCC Rules.

If you have any questions about this product, you may call;

Sony Customer Information Service Center
1-800-222-7669 or <http://www.sony.com/>

Declaration of Conformity

Trade Name: SONY
Model: VPL-VW95ES
Responsible party: Sony Electronics Inc.
Address: 16530 Via Esprillo,
San Diego, CA 92127
U.S.A.
Telephone Number: 858-942-2230

This device complies with part 15 of the FCC Rules. Operation is subject to the following two conditions: (1) this device may not cause harmful interference, and (2) this device must accept any interference received, including interference that may cause undesired operation.

For the customers in Canada

This Class B digital apparatus complies with Canadian ICES-003.

For the customers in Europe

The manufacturer of this product is Sony Corporation, 1-7-1 Konan, Minato-ku, Tokyo, 108-0075 Japan.

The Authorized Representative for EMC and product safety is Sony Deutschland GmbH, Hedelfinger Strasse 61, 70327 Stuttgart, Germany. For any service or

guarantee matters please refer to the addresses given in separate service or guarantee documents.

AVERTISSEMENT

Afin de réduire les risques d'incendie ou d'électrocution, ne pas exposer cet appareil à la pluie ou à l'humidité.

Afin d'écartier tout risque d'électrocution, garder le coffret fermé. Ne confier l'entretien de l'appareil qu'à un personnel qualifié.

CET APPAREIL DOIT ÊTRE RELIÉ À LA TERRE.

Pour les clients au Canada

Cet appareil numérique de la classe B est conforme à la norme NMB-003 du Canada.

Pour les clients en Europe

Le fabricant de ce produit est Sony Corporation, 1-7-1 Konan, Minato-ku, Tokyo, 108-0075 Japon.

Le représentant autorisé pour EMC et la sécurité des produits est Sony Deutschland GmbH, Hedelfinger Strasse 61, 70327 Stuttgart, Allemagne. Pour toute question concernant le service ou la garantie, veuillez consulter les adresses indiquées dans les documents de service ou de garantie séparés.

WARNING

Um die Gefahr von Bränden oder elektrischen Schlägen zu verringern, darf dieses Gerät nicht Regen oder Feuchtigkeit ausgesetzt werden.

Um einen elektrischen Schlag zu vermeiden, darf das Gehäuse nicht geöffnet

werden. Überlassen Sie Wartungsarbeiten stets nur qualifiziertem Fachpersonal.

DIESES GERÄT MUSS GEERDET WERDEN.

Für Kunden in Europa

Der Hersteller dieses Produkts ist Sony Corporation, 1-7-1 Konan, Minato-ku, Tokyo, 108-0075 Japan.

Der autorisierte Repräsentant für EMV und Produktsicherheit ist Sony Deutschland GmbH, Hedelfinger Strasse 61, 70327 Stuttgart, Deutschland. Bei jeglichen Angelegenheiten in Bezug auf Kundendienst oder Garantie wenden Sie sich bitte an die in den separaten Kundendienst- oder Garantiedokumenten aufgeführten Anschriften.

For kundene i Norge

Denne utstyret kan kobles til et IT-strømfordelingssystem.

Für Kunden in Deutschland

Entsorgungshinweis: Bitte werfen Sie nur entladene Batterien in die Sammelboxen beim Handel oder den Kommunen. Entladen sind Batterien in der Regel dann, wenn das Gerät abschaltet und signalisiert „Batterie leer“ oder nach längerer Gebrauchsdauer der Batterien „nicht mehr einwandfrei funktioniert“. Um sicherzugehen, kleben Sie die Batteriepole z.B. mit einem Klebestreifen ab oder geben Sie die Batterien einzeln in einen Plastikbeutel.

For the customers in Taiwan only



廢電池請回收

For the Customers in Brazil only

DESCARTE DE PILHAS E BATERIAS

Após o uso, as pilhas e/ou baterias poderão ser entregues ao estabelecimento comercial ou rede de assistência técnica autorizada.



Bateria Primária

Atenção:

Verifique as instruções de uso do aparelho certificando-se de que as polaridades (+) e (-) estão no sentido indicado. As pilhas poderão vazar ou explodir se as polaridades forem invertidas, expostas ao fogo, desmontadas ou recarregadas.

Evite misturar com pilhas de outro tipo ou com pilhas usadas, transportá-las ou armazená-las soltas, pois aumenta o risco de vazamento.

Retire as pilhas caso o aparelho não esteja sendo utilizado, para evitar possíveis danos na eventualidade de ocorrer vazamento.

As pilhas devem ser armazenadas em local seco e ventilado.

No caso de vazamento da pilha, evite o contato com a mesma.

Lave qualquer parte do corpo afetado com água abundante.

Ocorrendo irritação, procure auxílio médico.

Não remova o invólucro da pilha.

Mantenha fora do alcance das crianças. Em caso de ingestão procure auxílio médico imediatamente.

DESCARTE DE PILHAS E BATERIAS

Este produto contém bateria de alimentação integrada (não removível pelo usuário) que só deve ser substituída por profissionais qualificados. Ao fim da vida útil do equipamento, disponha-o em um ponto de coleta na Rede

Autorizada Sony ou nas lojas Sony, de forma a garantir o tratamento adequada bateria.

Note on use of the USB charging AC power adaptor AC-UD10

For the customer in the U.S.A.

The following FCC statement applies only to the version of this model manufactured for safe in the USA.

Other versions may not comply with FCC technical regulations.

This device complies with Part 15 of the FCC Rules. Operation is subject to the following two conditions: (1) this device may not cause harmful interference, and (2) this device must accept any interference received, including interference that may cause undesired operation.

Table of Contents

Precautions	7
-------------------	---

Location of Controls

Front/Right Side	8
Rear/Bottom	9
Remote Control	10

Connections and Preparations

Unpacking	11
Step 1: Installing the Projector	13
Before Setting Up the Projector	13
Positioning the Projector and a Screen	16
Step 2: Adjusting the Picture Position	20
Step 3: Connecting the Projector	25
Connecting to a VCR	25
Connecting to a Computer	27
Connecting to an Optional TMR-PJ1 3D Sync Transmitter	28
Step 4: Selecting the Menu Language	29

Projecting

Projecting the Picture on the Screen	31
Turning Off the Power	32
Using the Picture Position	33
Selecting the Wide Screen Mode	34
Watching 3D Video Images	37
Using the Simulated 3D Function	38
Using the 3D Glasses	39
Selecting the Picture Viewing Mode	41
Adjusting the Picture Quality	42
Selecting to Directly Adjust the Desired Menu Item	42
Adjusting the Picture Using Real Color Processing	43
Using the Supplied Software to Adjust the Picture Quality (ImageDirector3)	44

Using the Menus

Operation through the Menus	45
Picture Menu	49
Advanced Picture Menu	54
Screen Menu	55
Setup Menu	58
Function Menu	60
Installation Menu	63
Information Menu	66
About the Preset Memory No.	66

Others

About the Control for HDMI	67
About the x.v.Color	68
About the simulated 3D feature	68
Troubleshooting	69
Warning Indicators	72
Message Lists	73
Replacing the Lamp and the Air Filter and Cleaning the Ventilation Holes (intake)	75
Cleaning the Air Filter	78
Cleaning and the Screen of the Projector	78
How to Use the USB Charging AC Power Adaptor	79
Specifications	81
Preset Signals	83
Input Signals and Adjustable/ Setting Items	85
Compatible 3D Signals	87
3D Signals and Adjustable/Setting Items	87
Ceiling Installation	89
Index	93

Trademark Information

“PS3” is a registered trademark of Sony Computer Entertainment Inc.

HDMI, the HDMI logo and High-Definition Multimedia Interface are trademarks or registered trademarks of HDMI Licensing LLC.

“Blu-ray” and “Blu-ray Disk” are trademarks of Blu-ray Disc Association.

.....
Control for HDMI is an HDMI standard mutual control function which uses the HDMI CEC (Consumer Electronics Control) specification. This projector supports DeepColor, x.v.Color, LipSync, 3D signal and computer input signal of HDMI standards. It also supports HDCP.

Precautions

On safety

- Check that the operating voltage of your unit is identical with the voltage of your local power supply.
- Should any liquid or solid object fall into the cabinet, unplug the unit and have it checked by qualified personnel before operating it further.
- Unplug the unit from the wall outlet if it is not to be used for several days.
- To disconnect the cord, pull it out by the plug. Never pull the cord itself.
- The wall outlet should be near the unit and easily accessible.
- The unit is not disconnected to the AC power source (mains) as long as it is connected to the wall outlet, even if the unit itself has been turned off.
- Do not look into the lens while the lamp is on.
- Do not place your hand or objects near the ventilation holes. The air coming out is hot.

On preventing internal heat build-up

After you turn off the power with the I/⏻ (ON/STANDBY) switch, do not disconnect the unit from the wall outlet while the cooling fan is still running.

Caution

The projector is equipped with ventilation holes (intake) and ventilation holes (exhaust). Do not block or place anything near these holes, or internal heat build-up may occur, causing picture degradation or damage to the projector.

On repacking

Save the original shipping carton and packing material; they will come in handy if you ever have to ship your unit. For maximum protection, repack your unit as it was originally packed at the factory.

Safety precautions when using 3D Glasses

Warning

- Do not put the 3D Glasses in a fire.
- Do not disassemble the 3D Glasses.
- Do not use, charge, store, or leave the 3D Glasses near a fire, or in places with a high temperature, e.g., in direct sunlight, or in sun-heated cars.
- Use only the supplied USB cable.
- Do not charge the 3D Glasses with anything other than the supplied USB charging AC power adaptor.
- Do not allow water or foreign material to enter the 3D Glasses.

Safety precautions

- Use only the type of 3D glasses included with the projector. You should only use the 3D glasses for watching 3D video images. Do not use the 3D Glasses with other equipment, such as TV.
- If you observe flickering or flashing, turn off the lighting in the room.
- Not for use by children without proper adult supervision.
- Be careful not to pinch your fingers in hinges of the 3D glasses when bending the temple frames.
- Do not drop or modify these 3D glasses.
- If these glasses are broken, keep broken pieces away from your mouth or eyes.
- Not for use by children without proper adult supervision.

Location of Controls

Front/Right Side

You can use the buttons on the control panel with the same names as those on the remote control to operate the projector.

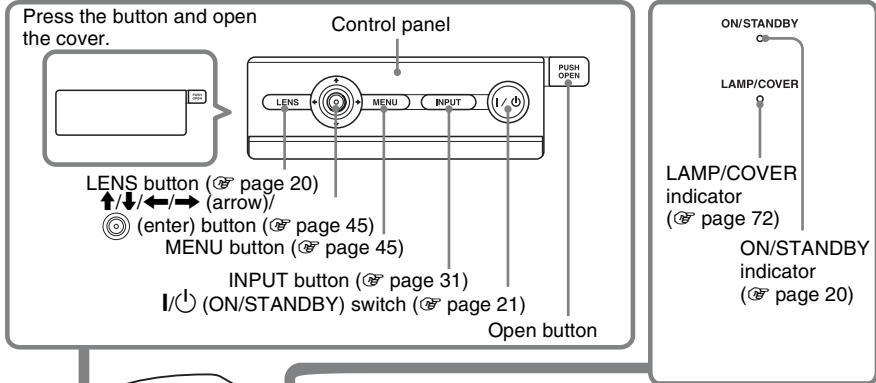

Note

While the ON/STANDBY indicator lights in orange, the power saving mode is on. (☞ page 59)

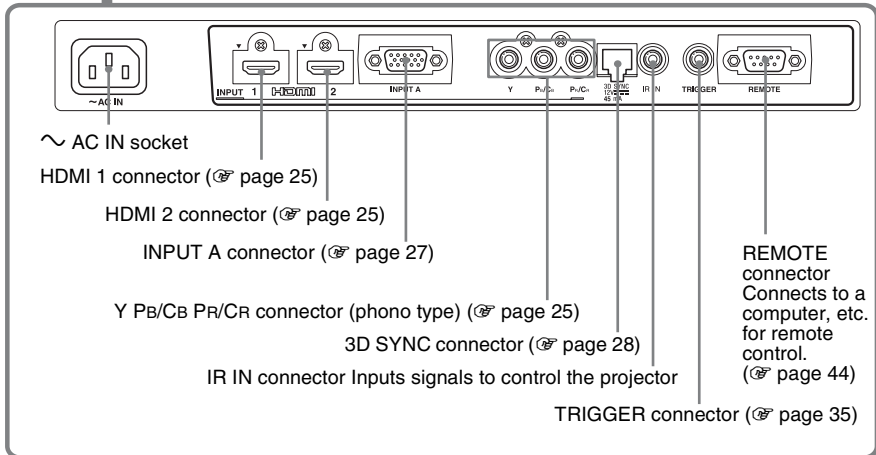
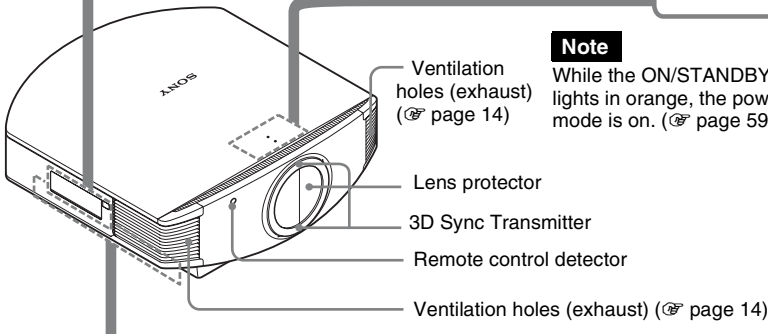

Rear/Bottom

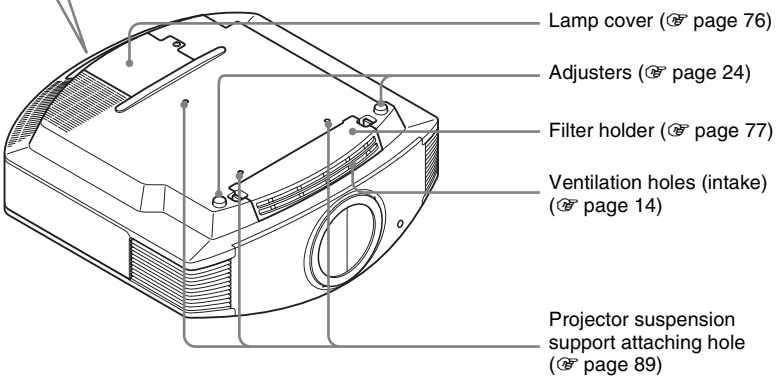
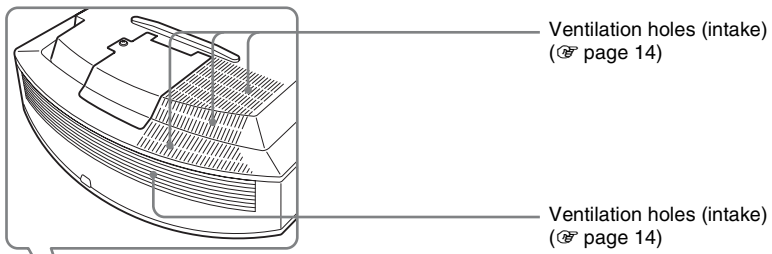
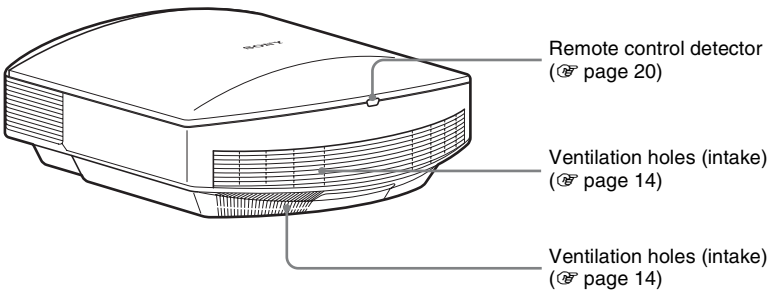

Remote Control

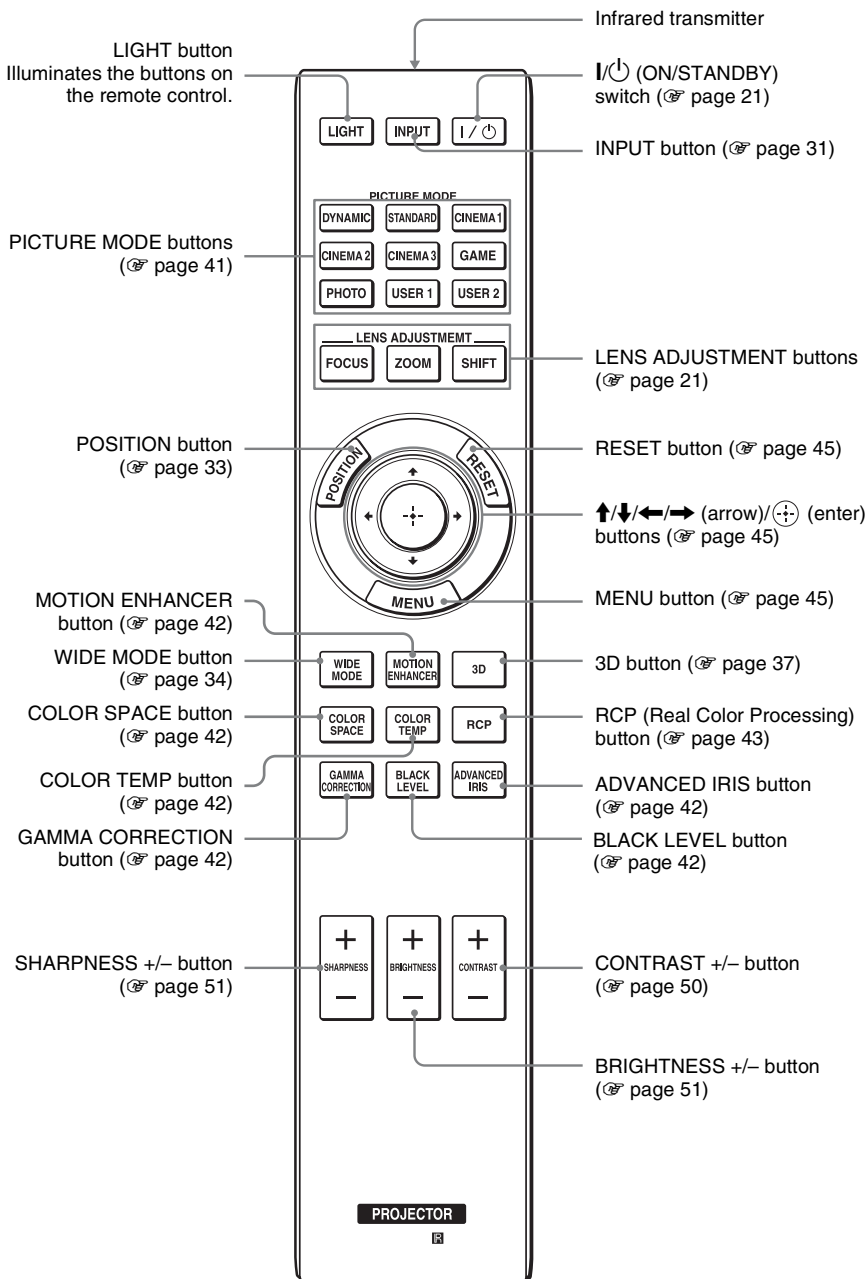

Connections and Preparations

This section describes how to install the projector and screen, how to connect the equipment from which you want to project the picture, etc.

Unpacking

Check the carton to make sure it contains the following items:

- Remote control (1) and Size AA (R6) manganese batteries (2)
- AC power cord for the projector (1)
- ImageDirector3 CD-ROM (1)
- Operating Instructions (this manual) (1)
- 3D glasses (2)
- Pouch for the 3D glasses (2)
- USB charging AC power adaptor (1)
- AC power cord for USB charging AC power adaptor (1)
- USB charging cable (GPHK05 - 2010 - 0007/SONY) (1.2 m) (1)

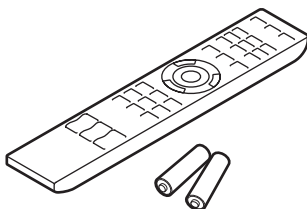

Inserting the batteries into the remote control

Insert the batteries  side first as shown in the illustration. Inserting them forcibly or with the polarities reversed may cause a short circuit and may generate heat.

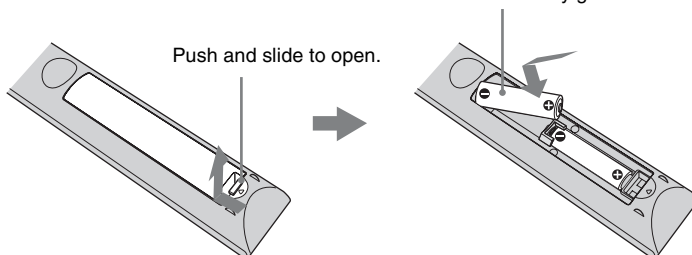

CAUTION

Danger of explosion if battery is incorrectly replaced.

Replace only with the same or equivalent type recommended by the manufacturer.

When you dispose of the battery, you must obey the law in the relative area or country.

ATTENTION

Il y a danger d'explosion s'il y a remplacement incorrect de la batterie. Remplacer uniquement avec une batterie du même type ou d'un type équivalent recommandé par le constructeur.

Lorsque vous mettez la batterie au rebut, vous devez respecter la législation en vigueur dans le pays ou la région où vous vous trouvez.

VORSICHT

Explosionsgefahr bei Verwendung falscher Batterien. Batterien nur durch den vom Hersteller empfohlenen oder einen gleichwertigen Typ ersetzen.

Wenn Sie die Batterie entsorgen, müssen Sie die Gesetze der jeweiligen Region und des jeweiligen Landes befolgen.

Installing batteries

Two size AA (R6) batteries are supplied for Remote Control.

To avoid risk of explosion, use size AA (R6) manganese or alkaline batteries.

Caution about handling the remote control

- Handle the remote control with care. Do not drop or step on it, or spill liquid of any kind onto it.
- Do not place the remote control in a location near a heat source, a place subject to direct sunlight, or a damp room.

Step 1: Installing the Projector

The projector displays pictures output from a VCR or other device.

The lens shift allows you to have broader options for placing the projector and viewing pictures easily.

Before Setting Up the Projector

Unsuitable installation

Do not place the projector in the following situations, which may cause malfunction or damage to the projector.

Poorly ventilated location

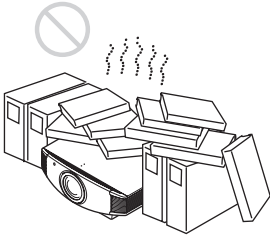

Leave space of more than 30 cm (11 7/8 inches) around the unit.

Hot and humid

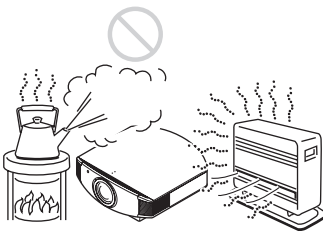

Locations subject to direct cool or warm air from an air-conditioner

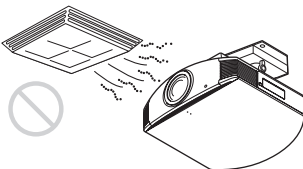

Installing the projector in such a location may cause a malfunction of the unit due to moisture condensation or rise in temperature.

Near a heat or smoke sensor

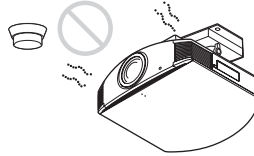

Malfunction of the sensor may occur.

Very dusty and extremely smoky locations



Install in a location away from walls

To maintain the performance and reliability of the projector, allow at least 30 cm (11 7/8 inches) between the projector and walls.

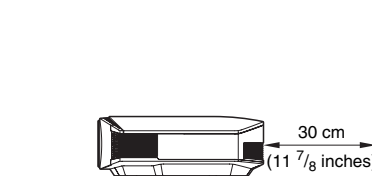
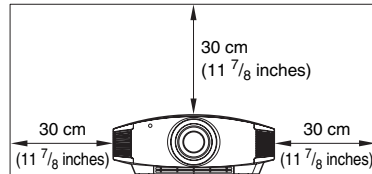

Improper use

Do not do any of the following while using the projector.

Blocking the ventilation holes (intake or exhaust)

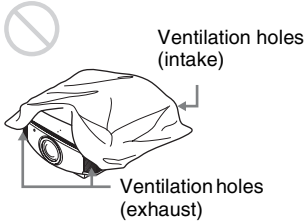

Tip

For details on the location of the ventilation holes (intake or exhaust), see “Location of Controls” on page 8.

Tilting front/rear and left/right

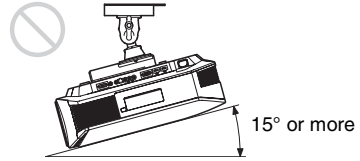
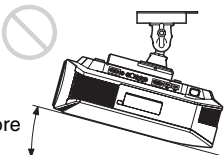
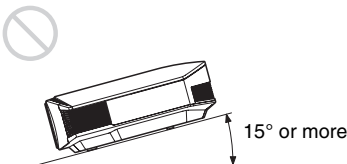
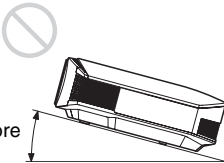
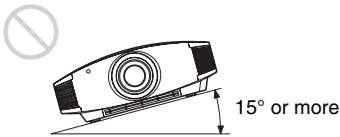

Avoid using the projector tilted at an angle of more than 15 degrees.

Do not install the projector anywhere other than on a level surface or on the ceiling. Installing the projector in such a location may result in uneven color uniformity or reduce the reliability of the effects of the lamp.

If the projector (unit) is tilted up or down, the image on the screen may be trapezoidal. Position the projector (unit) so that the lens is parallel to the screen (☞ page 19).

When installing the unit at high altitudes

When using the projector at an altitude of 1,500 m or higher, set “Cooling Setting” on the Setup  menu to “High” (☞ page 58). Failing to set this mode when using the projector at high altitudes could have adverse effects, such as reducing the reliability of certain components.

WARNING

When installing the unit, incorporate a readily accessible disconnect device in the fixed wiring, or connect the power plug to an easily accessible socket-outlet near the unit. If a fault should occur during operation of the unit, operate the disconnect device to switch the power supply off, or disconnect the power plug.

AVERTISSEMENT

Lors de l'installation de l'appareil, incorporer un dispositif de coupure dans le câblage fixe ou brancher la fiche d'alimentation dans une prise murale facilement accessible proche de l'appareil. En cas de problème lors du fonctionnement de l'appareil, enclencher le dispositif de coupure d'alimentation ou débrancher la fiche d'alimentation.

WARNING

Beim Einbau des Geräts ist daher im Festkabel ein leicht zugänglicher Unterbrecher einzufügen, oder der Netzstecker muss mit einer in der Nähe des Geräts befindlichen, leicht zugänglichen Wandsteckdose verbunden werden. Wenn während des Betriebs eine Funktionsstörung auftritt, ist der Unterbrecher zu betätigen bzw. der Netzstecker abzuziehen, damit die Stromversorgung zum Gerät unterbrochen wird.

Positioning the Projector and a Screen

The installation distance between the projector and a screen varies depending on the size of the screen or whether or not you use the lens shift features.

1 Determine the installation position of the projector and screen.

You can obtain a good quality picture if you position the projector so that the center of the lens is within the area indicated in gray in the illustration.

Use the values L , x and y in the table on page 17 or 18 as a guide.

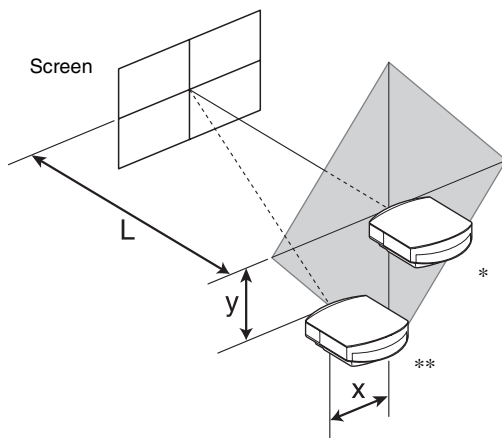

* Installation position not using lens shift ($x = 0$, $y = 0$)

** Example of installation position using lens shift (x , y)

L: Distance between the screen and the front end of the projector's lens.

x: Horizontal distance between the center of the screen and the center of the projector's lens.

y: Vertical distance between the center of the screen and the center of the projector's lens.

For installation of the projector on a ceiling, see "Ceiling Installation" (☞ page 89).

For details on the lens shift feature, see "Step 2: Adjusting the Picture Position" (☞ page 20).

When using the 16:9 aspect ratio screen size

Screen Size SS (inches)		40	60	80	100	120	150	200	250	300
(mm)		1016	1524	2032	2540	3048	3810	5080	6350	7620
L	minimum	1201 (47 3/8)	1825 (71 7/8)	2448 (96 1/2)	3072 (121)	3695 (145 1/2)	4631 (182 3/8)	6189 (243 3/4)	7748 (305 1/8)	9307 (366 1/2)
	maximum	1840 (72 1/2)	2782 (109 5/8)	3723 (146 5/8)	4664 (183 5/8)	5605 (220 3/4)	7017 (276 3/8)	9371 (369)	11724 (461 5/8)	14077 (554 1/4)
x		0 (0)	0 (0)	0 (0)	0 (0)	0 (0)	0 (0)	0 (0)	0 (0)	0 (0)
y		324 (12 7/8)	486 (19 1/4)	648 (25 5/8)	809 (31 7/8)	971 (38 1/4)	1214 (47 7/8)	1619 (63 3/4)	2024 (79 3/4)	2428 (95 5/8)
x		44 (1 3/4)	66 (2 5/8)	89 (3 5/8)	111 (4 3/8)	133 (5 1/4)	166 (6 5/8)	221 (8 3/4)	277 (11)	332 (13 1/8)
y		259 (10 1/4)	389 (15 3/8)	518 (20 1/2)	648 (25 5/8)	777 (30 5/8)	971 (38 1/4)	1295 (51)	1619 (63 3/4)	1943 (76 1/2)
x		89 (3 5/8)	133 (5 1/4)	177 (7)	221 (8 3/4)	266 (10 1/2)	332 (13 1/8)	443 (17 1/2)	553 (21 7/8)	664 (26 1/4)
y		194 (7 3/4)	291 (11 1/2)	389 (15 3/8)	486 (19 1/4)	583 (23)	728 (28 3/4)	971 (38 1/4)	1214 (47 7/8)	1457 (57 3/8)
x		133 (5 1/4)	199 (7 7/8)	266 (10 1/2)	332 (13 1/8)	398 (15 3/4)	498 (19 5/8)	664 (26 1/4)	830 (32 3/4)	996 (39 1/4)
y		130 (5 1/8)	194 (7 3/4)	259 (10 1/4)	324 (12 7/8)	389 (15 3/8)	486 (19 1/4)	648 (25 5/8)	809 (31 7/8)	971 (38 1/4)
x		177 (7)	266 (10 1/2)	354 (14)	443 (17 1/2)	531 (21)	664 (26 1/4)	886 (35)	1107 (43 5/8)	1328 (52 3/8)
y		65 (2 5/8)	97 (3 7/8)	130 (5 1/8)	162 (6 1/2)	194 (7 3/4)	243 (9 5/8)	324 (12 7/8)	405 (16)	486 (19 1/4)
x		221 (8 3/4)	332 (13 1/8)	443 (17 1/2)	553 (21 7/8)	664 (26 1/4)	830 (32 3/4)	1107 (43 5/8)	1384 (54 1/2)	1660 (65 3/8)
y		0 (0)	0 (0)	0 (0)	0 (0)	0 (0)	0 (0)	0 (0)	0 (0)	0 (0)

Unit: mm (inches)

To calculate the installation positions

$$L (\text{minimum}) = 31.1781 (1 \frac{7}{32}) \times SS - 46.1543 (1 \frac{13}{16})$$

$$L (\text{maximum}) = 47.0644 (1 \frac{27}{32}) \times SS - 42.3308 (1 \frac{21}{32})$$

$$y = -1.463 \times x (\text{mm or inch}) + 8.0942 (5 \frac{1}{16}) \times SS$$

When using the 4:3 aspect ratio screen size

Screen Size SS (inches)		40	60	80	100	120	150	200	250	300
(mm)		1016	1524	2032	2540	3048	3810	5080	6350	7620
L	minimum	1480 (58 ³ / ₈)	2243 (88 ³ / ₈)	3006 (118 ³ / ₈)	3770 (148 ¹ / ₂)	4533 (178 ¹ / ₂)	5677 (223 ⁵ / ₈)	7585 (298 ⁵ / ₈)	9493 (373 ³ / ₄)	11401 (448 ⁷ / ₈)
	maximum	2262 (89 ¹ / ₈)	3414 (134 ¹ / ₂)	4566 (179 ⁷ / ₈)	5718 (225 ¹ / ₈)	6870 (270 ¹ / ₂)	8598 (338 ⁵ / ₈)	11478 (452)	14357 (565 ¹ / ₄)	17237 (678 ⁵ / ₈)
x		0 (0)	0 (0)	0 (0)	0 (0)	0 (0)	0 (0)	0 (0)	0 (0)	0 (0)
y		396 (15 ⁵ / ₈)	594 (23 ¹ / ₂)	792 (31 ¹ / ₄)	991 (39 ¹ / ₈)	1189 (46 ⁷ / ₈)	1486 (58 ⁵ / ₈)	1981 (78)	2477 (97 ⁵ / ₈)	2972 (117 ¹ / ₈)
x		54 (2 ¹ / ₄)	81 (3 ¹ / ₄)	108 (4 ³ / ₈)	135 (5 ³ / ₈)	163 (6 ¹ / ₂)	203 (8)	271 (10 ³ / ₄)	339 (13 ³ / ₈)	406 (16)
y		317 (12 ¹ / ₂)	475 (18 ³ / ₄)	634 (25)	792 (31 ¹ / ₄)	951 (37 ¹ / ₂)	1189 (46 ⁷ / ₈)	1585 (62 ¹ / ₂)	1981 (78)	2377 (93 ⁵ / ₈)
x		108 (4 ³ / ₈)	163 (6 ¹ / ₂)	217 (8 ⁵ / ₈)	271 (10 ³ / ₄)	325 (12 ⁷ / ₈)	406 (16)	542 (21 ³ / ₈)	677 (26 ³ / ₄)	813 (32 ¹ / ₈)
y		238 (9 ³ / ₈)	357 (14 ¹ / ₈)	475 (18 ³ / ₄)	594 (23 ¹ / ₂)	713 (28 ¹ / ₈)	892 (35 ¹ / ₈)	1189 (46 ⁷ / ₈)	1486 (58 ⁵ / ₈)	1783 (70 ¹ / ₄)
x		163 (6 ¹ / ₂)	244 (9 ⁵ / ₈)	325 (12 ⁷ / ₈)	406 (16)	488 (19 ¹ / ₄)	610 (24 ¹ / ₈)	813 (32 ¹ / ₈)	1016 (40)	1219 (48)
y		158 (6 ¹ / ₄)	238 (9 ³ / ₈)	317 (12 ¹ / ₂)	396 (15 ⁵ / ₈)	475 (18 ³ / ₄)	594 (23 ¹ / ₂)	792 (31 ¹ / ₄)	991 (39 ¹ / ₈)	1189 (46 ⁷ / ₈)
x		217 (8 ⁵ / ₈)	325 (12 ⁷ / ₈)	433 (17 ¹ / ₈)	542 (21 ³ / ₈)	650 (25 ⁵ / ₈)	813 (32 ¹ / ₈)	1084 (42 ³ / ₄)	1355 (53 ³ / ₈)	1626 (64 ¹ / ₈)
y		79 (3 ¹ / ₈)	119 (4 ³ / ₄)	158 (6 ¹ / ₄)	198 (7 ⁷ / ₈)	238 (9 ³ / ₈)	297 (11 ³ / ₄)	396 (15 ⁵ / ₈)	495 (19 ¹ / ₂)	594 (23 ¹ / ₂)
x		271 (10 ³ / ₄)	406 (16)	542 (21 ³ / ₈)	677 (26 ³ / ₄)	813 (32 ¹ / ₈)	1016 (40)	1355 (53 ³ / ₈)	1693 (66 ³ / ₄)	2032 (80)
y		0 (0)	0 (0)	0 (0)	0 (0)	0 (0)	0 (0)	0 (0)	0 (0)	0 (0)

Unit: mm (inches)

To calculate the installation positions

$$L (\text{minimum}) = 38.1569 (1 \frac{1}{2}) \times SS - 46.1543 (1 \frac{13}{16})$$

$$L (\text{maximum}) = 57.5992 (2 \frac{9}{32}) \times SS - 42.3308 (1 \frac{21}{32})$$

$$y = -1.463 \times x (\text{mm or inch}) + 9.9060 (3 \frac{3}{8}) \times SS$$

2 Position the projector so that the lens is parallel to the screen.

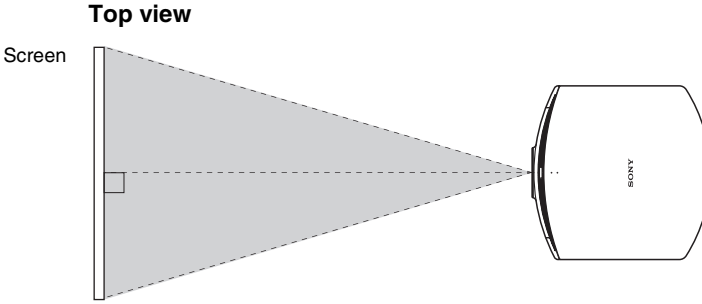

3 Project an image on the screen and adjust the picture so that it fits the screen (☞ page 20).

Note

When using a screen with an uneven surface, stripes pattern may rarely appear on the screen depending on the distance between the screen and the projector or the zooming magnifications. This is not a malfunction of the projector.

Step 2: Adjusting the Picture Position

Project an image on the screen and then adjust the picture position.

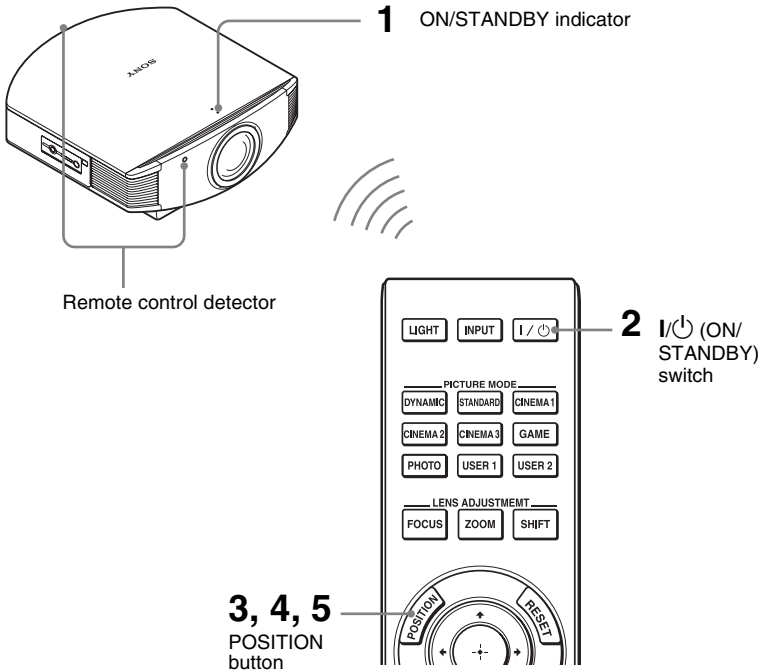

Tip

The I/⏻ (ON/STANDBY), INPUT, MENU, and ↑/↓/←/→/⊙ (joystick) buttons on the side panel of the projector function the same as those on the remote control. The LENS button functions in the same way as the LENS ADJUSTMENT (FOCUS, ZOOM, SHIFT) button of the remote control.

Note

Depending on the installation location of the projector, you may not control it with the remote control. In this case, point the remote control to the screen instead of the projector.

ON/STANDBY



Lights in red.

1 After connecting the AC power cord to the projector plug the AC power cord into a wall outlet.

The ON/STANDBY indicator lights in red and the projector goes into standby mode.

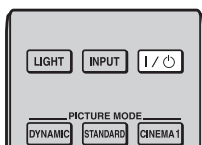

ON/STANDBY



Flashes in green for a while (tens of seconds) and then lights in green.

2 Press the I/⏻ (ON/STANDBY) switch to turn on the projector.

The lens protector will open. The ON/STANDBY indicator flashes in green, and then lights in green. When the ON/STANDBY indicator flashes, “Starting...” appears on the screen.

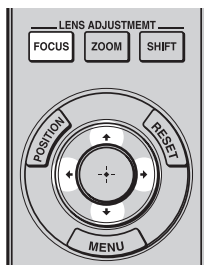

3 Adjust the focus.

Press the LENS ADJUSTMENT (FOCUS) button to display the Lens Focus adjustment window (test pattern). Then adjust the focus of the picture by pressing the $\uparrow/\downarrow/\leftarrow/\rightarrow$ buttons.

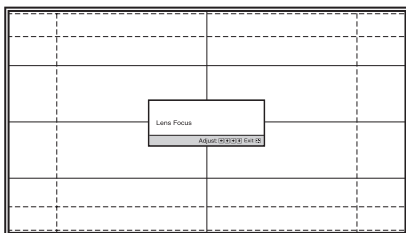

Tip

- When “Lens Control” is set to “Off” on the Installation menu, you cannot adjust the focus, the picture size or the proper position by pressing the FOCUS, ZOOM or SHIFT buttons (page 63). When “Test Pattern” is set to “Off” on the Function menu, the test pattern is not displayed (page 62).
- The test signal is displayed for 1 minute. Press the button to clear the test signal display before that.

Note

Adjust the lens by using buttons on the remote control or the control panel of the projector. Never make adjustments by directly turning the lens with your hands, which may cause damage or malfunction to the projector.

When adjusting the lens, each time you press the LENS button on the unit, the lens adjustment function switches between “Lens Focus, Lens Zoom and Lens Shift”.

FOCUS → ZOOM → SHIFT



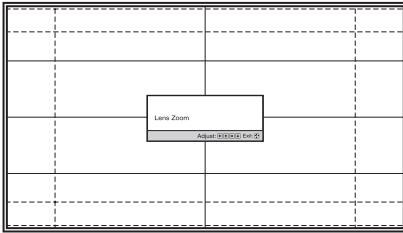
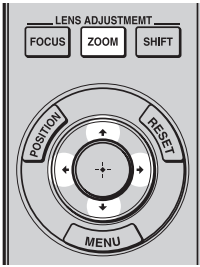

4 Adjust the picture size.

Press the LENS ADJUSTMENT (ZOOM) button to display the Lens Zoom adjustment window (test pattern). Then adjust the size of the picture by pressing the $\uparrow/\downarrow/\leftarrow/\rightarrow$ buttons.



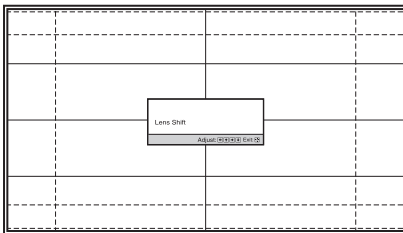
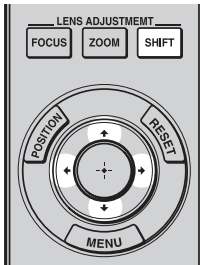

To make the picture larger, press \uparrow/\rightarrow .
To make the picture smaller, press \downarrow/\leftarrow .



5 Adjust the picture position.

Press the LENS ADJUSTMENT (SHIFT) button to display the Lens Shift adjustment window (test pattern). Then adjust to the proper position of the picture by pressing the $\uparrow/\downarrow/\leftarrow/\rightarrow$ buttons.

Tip

- When “Lens Control” is set to “Off” on the Installation  menu, you cannot adjust the picture position ( page 63).
When “Test Pattern” is set to “Off” on the Function  menu, the test pattern is not displayed ( page 62).
- The test signal is displayed for 1 minute.
Press the  button to clear the test signal display before that.

Note

When adjusting the window position, do not touch the lens unit, otherwise your fingers may be pinched by the moving parts.

To adjust the horizontal position

Press ←/→.

The picture projected on the screen moves right or left by a maximum of 25% of the screen width from the center of the lens.

25% 1 screen width 25%

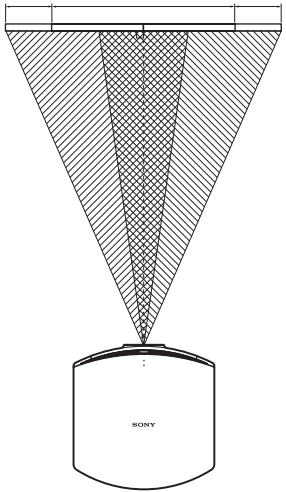

Top view

- : Picture position when moving the picture to the left at maximum
- : Picture position when moving the picture to the right at maximum

To adjust the vertical position

Press ↑/↓.

The picture projected on the screen moves up or down by a maximum of 65% of the screen height from the center of the lens.

Side view

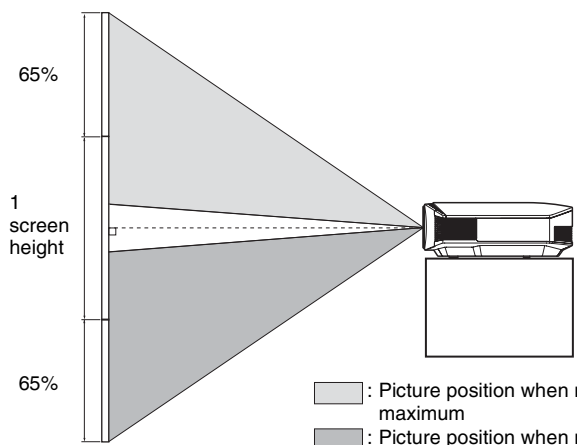

- : Picture position when moving the picture upward at maximum
- : Picture position when moving the picture downward at maximum

Note

The range to move the picture projected on the screen can be adjusted only within the octagon area illustrated below. In this connection, see “Positioning the Projector and a Screen” (📄 page 16) as well.

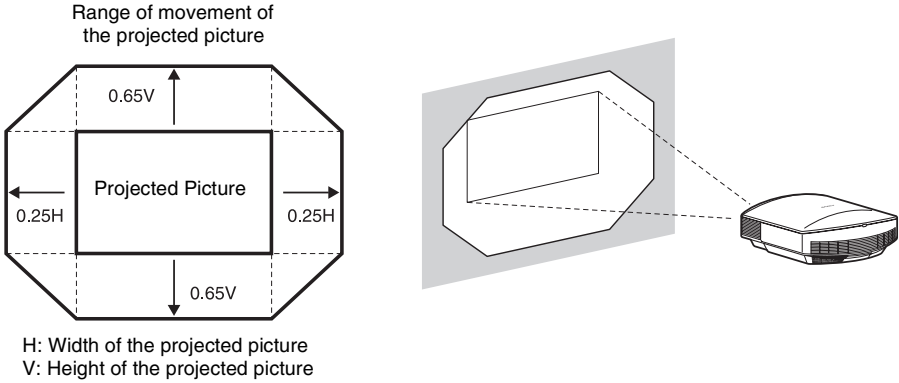

To adjust the tilt of the installation surface

If the projector is installed on an uneven surface, use the adjusters to keep the projector level.

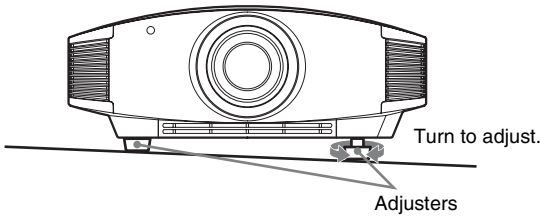

Notes

- Pointing the projector at too high or too low of a tilt will result in trapezoidal distortion in the projected image.
- Be careful not to catch your finger when turning the adjusters.

Lens Focus adjustment window (test pattern)

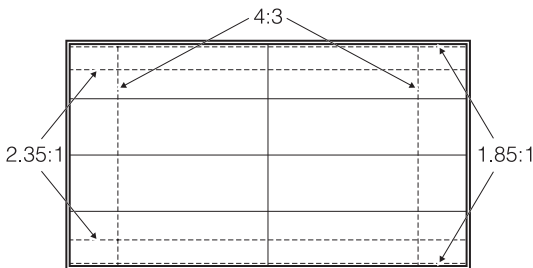



Step 3: Connecting the Projector

When making connections, be sure to do the following:

- Turn off all equipment before making any connections.
- Use the proper cables for each connection.
- Insert the cable plugs properly; poor connection at the plugs may cause a malfunction or poor picture quality. When pulling out a cable, be sure to pull it out from the plug, not the cable itself.
- Refer to the operating instructions of the connected equipment.

Connecting to a VCR

To connect to equipment with HDMI output connectors

You can enjoy better picture quality by connecting a DVD player/recorder, Blu-ray Disc player/recorder, or PS3[®] equipped with HDMI output to the HDMI input of the projector. Moreover, if you have a Control for HDMI compatible equipment, you can operate the projector synchronizing with the Control for HDMI compatible equipment. For details, see the Function  menu ( page 60) and “About the Control for HDMI” ( page 67).

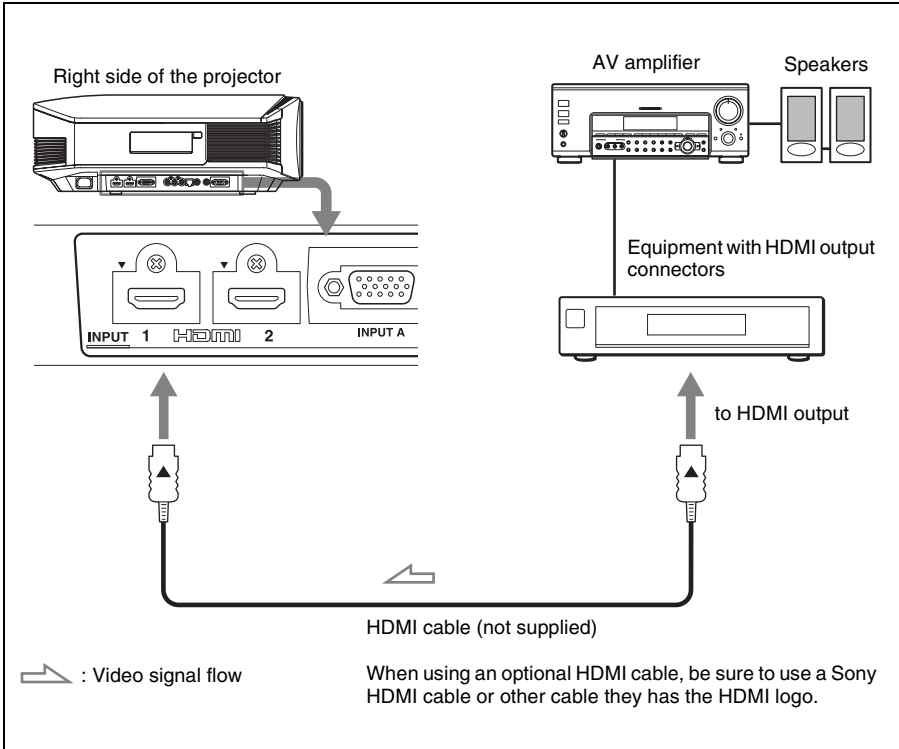

Notes

- Use a high-speed HDMI cable. With a standard HDMI cable, images of 1080p, DeepColor, and 3D video images may not be displayed properly.
- When connecting an HDMI cable to the projector, make sure the ▼ mark on the upper part of the HDMI input of the projector and the ▲ mark on the connector of the cable is set at the same position.
- If the picture from equipment connected to the projector with an HDMI cable is not clear, check the settings of the connected equipment.

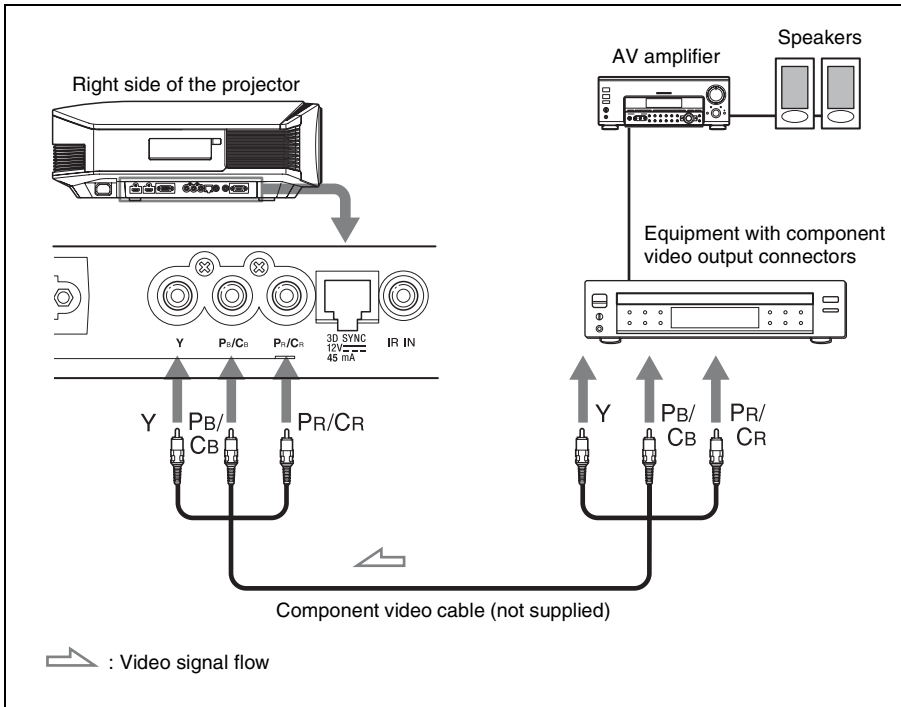

To connect to equipment with component video output connectors

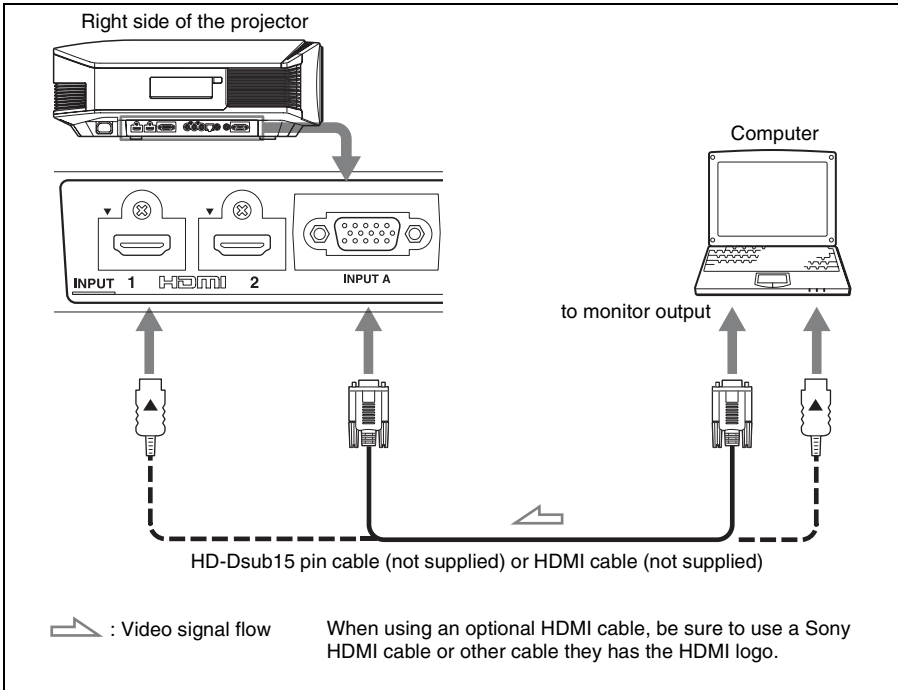

Connecting to a Computer



Tip

When connecting an HD-Dsub15 pin cable, set "Input-A Signal Sel." on the Setup  menu to "Auto" or "Computer." If the input signal does not appear properly, set it to "Computer" ( pages 59, 73).

Notes

- Use a high-speed HDMI cable. With a standard HDMI cable, images of 1080p, DeepColor, and 3D video images may not be displayed properly.
- When connecting an HDMI cable, make sure the ▼ mark on the upper part of the HDMI input of the projector and the ▲ mark on the connector of the cable is set at the same position.
- If you set your computer, such as a notebook type, to output the signal to both computer's display and this equipment, the picture of the equipment may not appear properly. Set your computer to output the signal to only the external monitor.
For details, refer to the computer's operating instructions supplied with your computer. For settings of the computer, consult with the manufacturer of the computer.
- If the picture from equipment connected to the projector with an HDMI cable is not clear, check the settings of the connected equipment.

Connecting to an Optional TMR-PJ1 3D Sync Transmitter

The projector incorporates a 3D Sync Transmitter. Depending on the installation environment of the projector, the 3D glasses may not receive 3D signals properly from the projector's built-in 3D Sync Transmitter. In this case, connect an optional TMR-PJ1 3D Sync Transmitter and place it near your viewing position.

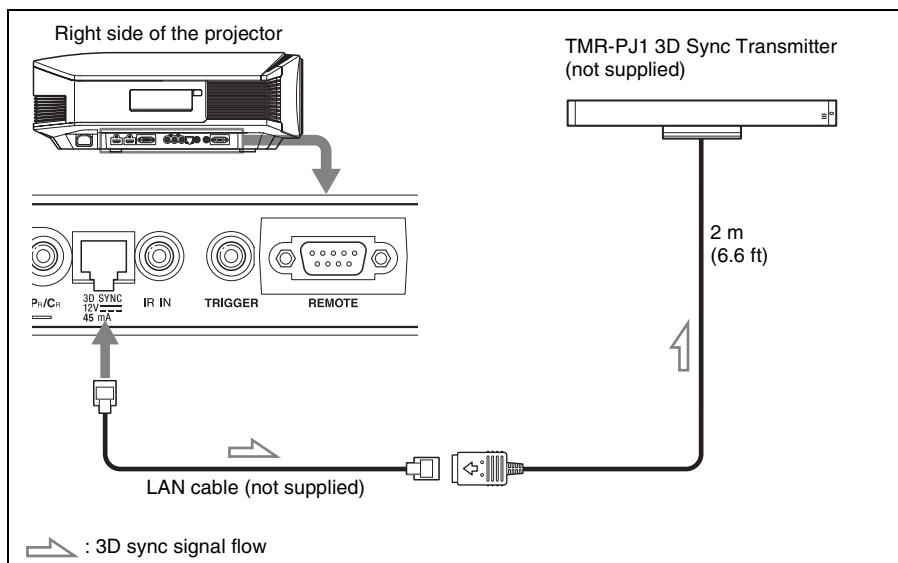

Tip

Place the optional TMR-PJ1 3D Sync Transmitter directly facing the 3D glasses. Also, in order to stabilize operation of the 3D glasses, it is recommended that you place the 3D Sync Transmitter near your viewing position.

CAUTION

Be sure to use straight-type LAN cable of up to 15 m labeled TYPE CM, and do not use an extension cord.

Notes

- The 3D SYNC connector is dedicated for the optional 3D Sync Transmitter. Do not connect computers or other network devices, to avoid malfunction.
- Be sure to use straight-type LAN cable (not supplied) labeled Cat-7 (Category 7). If you use other than the specified cable, the 3D Sync Transmitter may occasionally not work.
- Be sure to use cable of up to 15 m, and do not use an extension cord. Also, keep the LAN cable away from any AC power cords as much as possible.
- Up to one TMR-PJ1 can be connected to a projector. Never connect multiple TMR-PJ1 units, which may cause a malfunction.
- When connected to the TMR-PJ1, the built-in 3D Sync Transmitter feature of the projector will automatically turn off. You cannot use both at the same time.

Step 4: Selecting the Menu Language

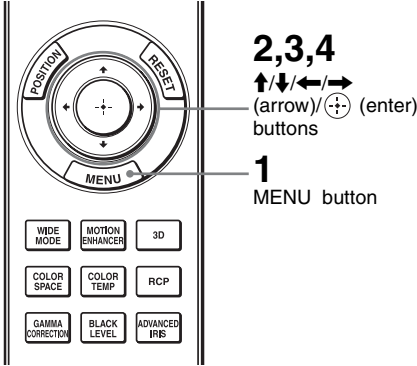

You can select one of 16 languages for displaying the menu and other on-screen displays. The factory default setting is English. To change the current menu language, set the desired language with the menu screen.

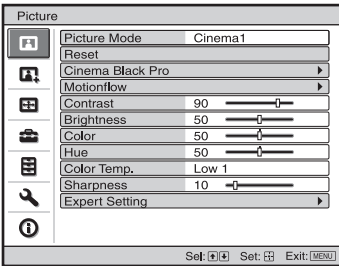
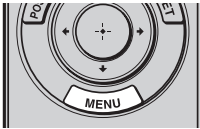

- 1 Press MENU.**
The menu appears.

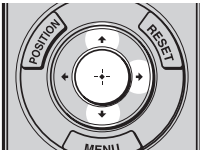



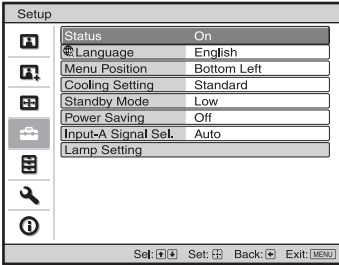

- 2** Press **↑/↓** to select the **Setup**  menu, and press **→** or .

The setting items of the selected menu appears.

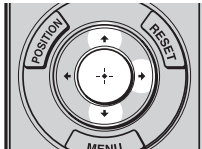

- 3** Press **↑/↓** to select “Language,” and press **→** or .



- 4** Press **↑/↓/←/→** to select a language, and press .

The menu changes to the selected language.

To clear the menu

Press MENU.

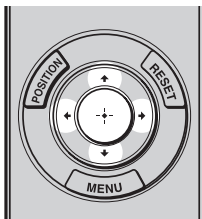

Projecting

This section describes how to operate the projector to view the picture from the equipment connected to the projector. It also describes how to adjust the quality of the picture to suit your taste.

Projecting the Picture on the Screen

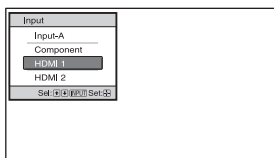
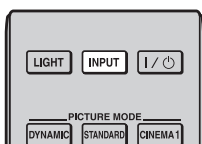

Example: To view the picture from the video equipment connected to the HDMI 1 connector of this unit.

- 1 Power on both the projector and the equipment connected to the projector.**
- 2 Press INPUT to display the input palette on the screen.**
- 3 Select the equipment from which you want to display images.**

Press INPUT repeatedly or press **↑/↓** (enter) to select the equipment from which to project.

To view the picture from	Press INPUT to display
RGB/component equipment connected to the INPUT A connector	Input-A*
Component equipment connected to the Y Pb/Cb Pr/CR connector	Component
Equipment connected to the HDMI 1 connector	HDMI 1
Equipment connected to the HDMI 2 connector	HDMI 2

* Set “Input-A Signal Sel.” on the Setup menu according to the signal input. When you set it to “Auto,” and cannot display the picture properly, select an appropriate signal according to the input signal (pages 59, 66).

Tips

- When “Auto Input Search” is set to “On” on the Function menu, only input terminals with effective signals are displayed in the input palette.
- When “Status” is set to “Off” on the Setup menu, the input palette does not appear. Press of the INPUT button to switch between input terminals in sequence.
- When the “Control for HDMI” is set to “On” on the Function menu, the input terminal with effective signals is automatically displayed, synchronizing with the operation of the equipment connected to HDMI 1 or HDMI 2 input of the projector. (Only when the connected equipment supports Control for HDMI compatible.)





Notes on input of HDMI signal

The projector adjusts the RGB dynamic range of the equipment connected with HDMI cable to the following to suit the HDMI standard and display in best picture quality.

When video signal is input: Limited (16-235)

When computer signal is input: Full (0-255)

When a signal other than those of HDMI standard is input, the following symptoms may occur.

- When a video signal is input, the color gradation of the dark area or bright area may become unclear, or texts may become faded. In this case, switch the RGB dynamic range of the connected equipment to Limited (16-235). If this adjustment is unavailable, adjust “Brightness,” “Contrast,” or “Sharpness” on the Picture  menu of the projector ( pages 50, 51).
- * When a computer signal is input, the texts may become faded. In this case, adjust the “Sharpness” on the Picture  menu ( page 51). (* 1,920 × 1,080 or 1,280 × 720 signals)

Turning Off the Power

1 Press the I/⏻ (ON/STANDBY) switch.

A message “POWER OFF?” appears on the screen.

2 Press the I/⏻ (ON/STANDBY) switch again before the message disappears.

The lens protector will close. Be careful not to catch your fingers or any objects.

The ON/STANDBY indicator flashes in green and the fan continues to run to reduce the internal heat. First, the ON/STANDBY indicator flashes quickly, during which you will not be able to light up the ON/STANDBY indicator with the I/⏻ (ON/STANDBY) switch.

Note

Never disconnect the AC power cord while the indicator is flashing.

The fan stops and the ON/STANDBY indicator changes from flashing green to remaining red.

The power is turned off completely, and you can disconnect the AC power cord.

You can turn off the projector by holding the I/⏻ (ON/STANDBY) switch for about 1 second, instead of performing the above steps.

Using the Picture Position

You can store the five lens settings (combination of focus, window size, window position) and you can recall those settings.

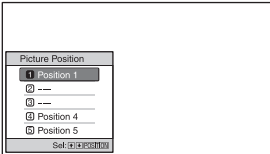
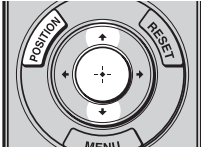

1 Press the POSITION button.

The Picture Position Selecting Palette is displayed.

2 Press the $\uparrow/\downarrow/\oplus$ buttons to select the position.

The lens position is automatically adjusted to the position that you select. Store or delete the Lens settings in the “Picture Position” of the Screen \oplus Menu (☞ page 55). A position where a lens settings is not stored is displayed as “---.”

Notes

- After you have selected and confirmed the lens position, the lens starts to move automatically. Do not touch the lens and the area around the lens, otherwise it may cause injury or a malfunction.
- If you press any button on the projector while the lens is moving, the lens stops. In this case, select the lens position again or adjust the lens manually.
- The Picture Position function is not guaranteed to reproduce the lens settings precisely.
- In order to project either a 16:9 or 2.35:1 aspect ratio picture onto a 2.35:1 screen using lens zoom, install the unit within one of the ranges shown in the table below. If you install the unit out of the correct range, both sizes of picture will not be available. In the case of using lens shift, you may not be able to use the function, even within the correct range.

Screen Size (2.35:1)	1,270 (50)	1,905 (75)	2,540 (100)	3,175 (125)
Projection distance*	1,600 to 1,837 ($62 \frac{31}{32}$ to $72 \frac{5}{16}$)	2,423 to 2,777 ($95 \frac{3}{8}$ to $109 \frac{5}{16}$)	3,245 to 3,717 ($127 \frac{25}{32}$ to $146 \frac{5}{16}$)	4,068 to 4,656 ($160 \frac{5}{32}$ to $183 \frac{5}{16}$)
Screen Size (2.35:1)	3,810 (150)	5,080 (200)	6,350 (250)	7,214 (284)
Projection distance *	4,891 to 5,596 ($192 \frac{9}{16}$ to $220 \frac{5}{16}$)	6,537 to 7,475 ($257 \frac{3}{8}$ to $294 \frac{5}{16}$)	8,183 to 9,355 ($322 \frac{5}{32}$ to $368 \frac{5}{16}$)	9,302 to 10,633 ($366 \frac{7}{32}$ to $418 \frac{5}{8}$)

Unit: mm (inches)

* Projection distance: Horizontal difference between the front end of the projector’s lens and the screen.

Selecting the Wide Screen Mode

You can enjoy various wide screen modes according to the video signal received.

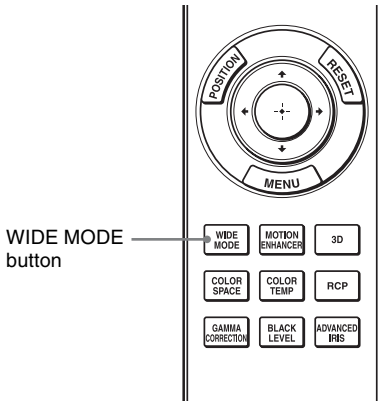

Press WIDE MODE.

Each time you press the button, you can select the “Wide Mode” setting.

You can also select it using the menu (☞ page 56).

Original image

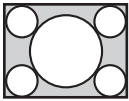

When the Wide Mode is operated

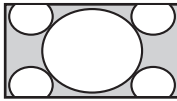

Wide Zoom (When a video signal is input)

A 4:3 aspect ratio picture is enlarged naturally to fill the screen. The upper and lower portions of the screen are slightly cut off.

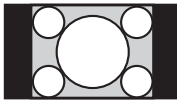
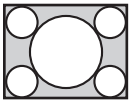

Normal (When a video signal is input)

A 4:3 aspect ratio picture is displayed in the center of the screen and enlarged to fill the screen vertically.

Squeezed

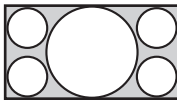
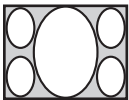

Full (When a video signal is input)

A picture squeezed to 4:3 aspect ratio is displayed in its original aspect ratio. When a 4:3 aspect ratio picture is displayed, the picture is enlarged horizontally to fill the 16:9 screen.

Tip

Squeezed: An original 16:9 aspect ratio picture is recorded horizontally compressed to a 4:3 picture.

Letterbox picture with side panels

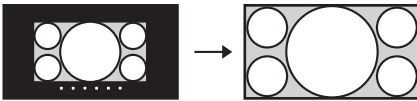

Letterbox picture

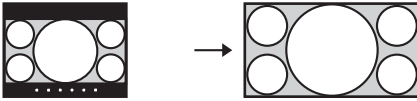

When using an Anamorphic lens

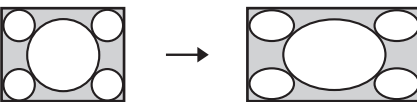

Zoom

A 16:9 aspect ratio picture is enlarged vertically and horizontally in the same ratio to fill the screen. Use this mode to view a letterbox picture or a letterbox picture with side panels.

If the subtitle of a movie, etc. is hidden and cannot be seen, adjust the screen with “Vertical Size” and “V Center” to display the subtitle (Ⓞ page 56).

Anamorphic Zoom (When a video signal is input)

A 2.35:1 aspect ratio picture is converted to a normal 16:9 picture on the screen. This mode is best suited when using a commercially available Anamorphic lens which converts a normal 16:9 aspect ratio picture to a 2.35:1 picture.

Also, when “Trigger Select” on the Installation  menu is set to “Anamorphic Zoom,” 12 V signal is output from the TRIGGER connector and can be used as sync signal that synchronizes the projector with the Anamorphic lens (Ⓞ page 63).

Full 1 (When a computer signal is input)

Displays a picture on the whole of the screen without changing the aspect ratio of the original picture.

Full 2 (When a computer signal is input)

Displays a picture on the whole of the screen.

Notes

- You can adjust the vertical position of the picture with “V Center” and “Vertical Size” on the Screen  menu only when “Zoom” is selected (Ⓞ page 57).
- Depending on the type of Anamorphic lens, part of the screen may be cut off when you zoom in on the picture. Check the specifications of the Anamorphic lens you use.
- When the aspect ratio of the computer signal is 16:9 or wider, the “Wide Mode” setting is fixed at “Full 1.”

- When a 3D video image is displayed, the “Wide Mode” setting is fixed at “Full.”

Notes on selecting the wide screen mode

The projector is featured with the WIDE MODE. When changing the settings of WIDE MODE, use caution as described below.

- Select the wide screen mode taking into account that changing the aspect ratio of the original picture will provide a different look from that of the original image.
- Note that if the projector is used for profit or for public viewing, modifying the original picture by switching to the Wide Mode may constitute an infringement of the rights of authors or producers, which are legally protected.

Watching 3D Video Images

You can enjoy powerful 3D video images, such as from 3D games and 3D Blu-ray Discs, using the supplied the 3D glasses.

1 Turn on the HDMI equipment for 3D compatibility connected to the projector then play the 3D content.

For details on how to play 3D content, refer to the operating instructions for the connected equipment.

2 Turn on the projector and project the 3D video image onto the screen.

For details on how to project the image, see “Projecting the Picture on the Screen” (📖 page 31).

3 Turn on the 3D glasses, after checking for comfortable fit.

For details on how to use the 3D glasses, see “Using the 3D Glasses” (📖 page 39).

Tips

- The factory default setting for “2D-3D Display Sel.” is “Auto” to allow projecting 3D video images automatically when the projector detects 3D signals.
- To convert 3D video images to 2D video images, set “2D-3D Display Sel.” to “2D” (📖 page 60).

Notes

- It may not be possible to display 3D video image, depending on the type of signal. Set the “2D-3D Display Sel.” to “3D,” and “3D Format” to “Side-by-Side” or “Over-Under” to suit the format of the 3D content you want to watch.
- Use the 3D glasses within the communication range (📖 page 39).
- You can watch 3D video images only when signals from HDMI input. When connecting 3D equipment such as a 3D game or 3D Blu-ray player to the projector, use an HDMI cable.
- There are differences in perception of 3D video images among individuals.
- When the temperature of the usage environment is low, the 3D effect may be diminished.

Adjusting/Setting the 3D functions using the menu

You can adjust/set the 3D functions with “3D Settings” of the Function  menu. For details, see “3D Settings” (📖 page 60).

You can display the “3D settings” by pressing the 3D button on the remote control.

Using the Simulated 3D Function

You can convert normal 2D video images to 3D video images.

Tip

For details on how to operate the on-screen menu, see “Operation through the Menus” (📖 page 45).

1 Display the Function menu and select “3D Settings.”

You can display the “3D settings” by pressing the 3D button on the remote control.

2 Set “2D-3D Display Sel.” to “3D,” and then press ➡ to display “3D Format.”

3 Set “3D Format” to “Simulated 3D” (📖 page 60).

Tips

- Use the supplied 3D glasses.
- The projector automatically returns to 2D display and “2D-3D Display Sel.” returns to “Auto” after approximately one hour when converting 2D video images to 3D video images using the simulated 3D function.

Notes

- “2D-3D Display Sel.” cannot be set to “3D” for some video sources. For available 3D signals, see “Compatible 3D Signals” (📖 page 87).
- The simulated 3D feature may have limited effect, depending on the video source.
- There are differences in perception of 3D video images converted by the simulated 3D function among individuals.

Using the 3D Glasses

The 3D glasses receive signals the 3D Sync Transmitter built into the front of the projector and reflected to the glasses from the screen. When watching 3D video images using the 3D glasses, face squarely toward the screen.

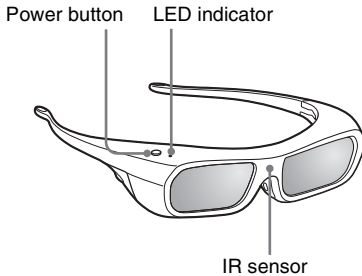

- 1 Put on the 3D glasses.
- 2 Press the power button on the 3D glasses.
The LED indicator lights up in green.
- 3 Turn toward the screen.

Precautions for use

- The 3D glasses receive, infrared signals sent by the 3D Sync Transmitter built into the front of the projector and reflected to the glasses from the screen.
Mis-operation may occur if:
 - The 3D glasses do not face the screen
 - If there are objects blocking the path between the 3D glasses and the screen
 - The viewing position is too far from the screen or the distance between the projector and 3D glasses is too great
 - If the Anamorphic Zoom lens is mounted on the projector
 - If there are other infrared communication devices nearby
- There are differences in perception of 3D video images among individuals.
- When the temperature of the usage environment is low, the 3D effect may be diminished.

3D glasses communication range

Figures A and B below indicate the communication range of the 3D glasses. If you try to watch 3D video images from a distance greater than the communication range or install the projector outside the communication range, the 3D glasses may not be able to display the images properly. Also, the viable angles and distance vary depending on the screen type, environment of the room, and installation environment of the projector.

Figure A: 3D glasses communication range (distance from the screen)

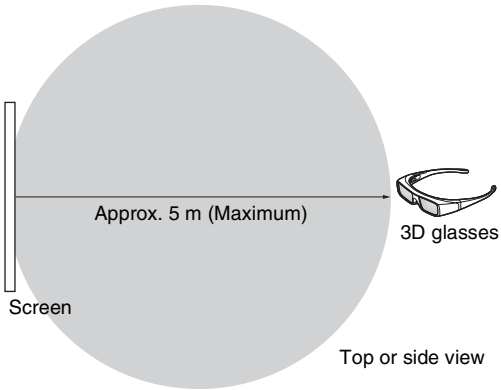
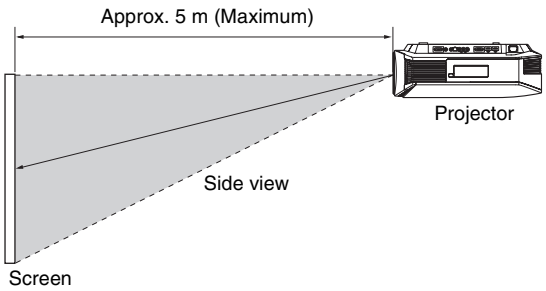

Figure B: 3D sync signal communication distance between the projector and screen



Selecting the Picture Viewing Mode

You can select the picture viewing mode that best suits the type of program or room conditions.

The availability of each picture mode depends on whether the video image is 2D or 3D.

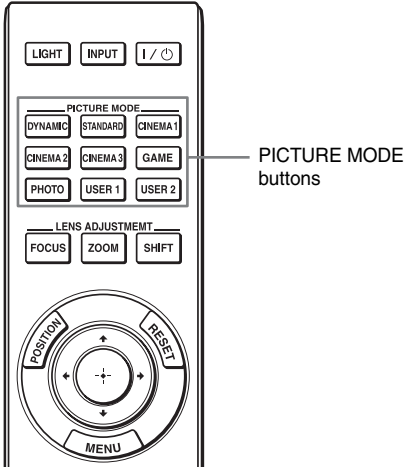

Press one of the PICTURE MODE buttons.

DYNAMIC

Project bright images with sharp, vivid picture quality.

STANDARD

Ideal for projecting TV programs, sports, concerts, and other video images.

CINEMA 1

Picture quality suited for watching movies.

CINEMA 2

Picture quality suited for digital cinema content.

CINEMA 3

Simulates production/editing studio picture quality.

GAME

Picture quality suited for playing video games.

PHOTO

Ideal for projecting still images taken with a digital camera.

USER 1, USER 2

Adjusts the picture quality to suit your taste.

Adjusting the Picture Quality

You can easily adjust the picture quality that suits your taste by selecting the adjustment items with the remote control. The adjusted data can be stored in each picture mode.

Selecting to Directly Adjust the Desired Menu Item

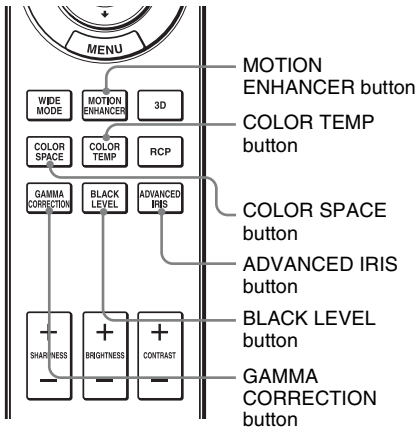

The following menu items can be adjusted by using the buttons on the remote control.

“Motion Enhancer”



“Color Temp.”

“Color Space”

“Advanced Iris”

“Black Level Adj.”

“Gamma Correction”

Press the following buttons of the desired menu item repeatedly to adjust the picture quality to suit your taste. For details on each menu item, see the Picture  menu ( page 49).

Adjusting the Picture Using Real Color Processing

The Real Color Processing (RCP) feature allows you to adjust the color, hue, and brightness of each target of the projected picture you specify independently. You can thus obtain a picture more suitable to your taste.

Tip

Freeze the scene of the video source when you are adjusting the picture using Real Color Processing.

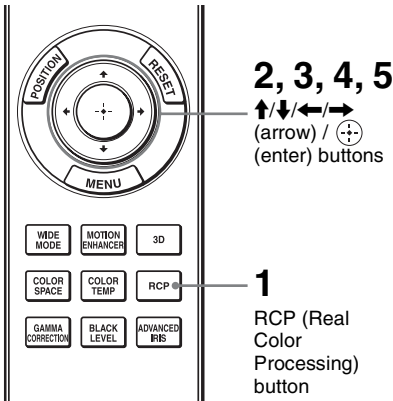

- 1 Press RCP on the remote control.
- 2 Press **↑/↓** to select “User 1,” “User 2” or “User 3,” then press **→**.

The RCP (Real Color Processing) window appears.

- 3 Select the target color you want to adjust.

Repeat steps **1** and **2** described below to specify the target color.

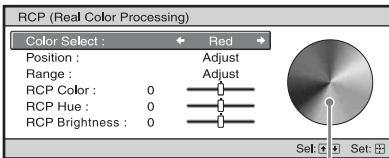

Reference palette

- 1 Press **↑/↓** to select “Color Select,” then press **←/→** to select the color you want to adjust among “Red,” “Yellow,” “Green,” “Cyan,” “Blue” and “Magenta.”

Only the portions that correspond to the specified color will be colored and the other portions will be displayed in black and white. The reference palette in the RCP window also shows the adjustable colors. Select the desired setting to adjust the color on the projected image using the reference palette as a guide.

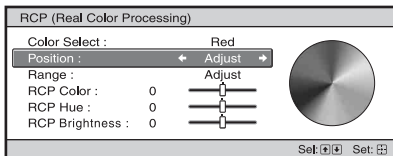

2 Press **↑/↓** to select “Position” or “Range,” and specify it more delicate color position and color range you want to adjust using **←/→**.

4 Adjust the color of the specified portions.

Press **↑/↓** to select “RCP Color,” “RCP Hue” or “RCP Brightness,” then adjust the color or hue of the portions selected in step 3 to suit your taste using **←/→** while watching the projected picture. The picture is returned to normal color during adjustment.

5 After the adjustment is complete, press **⊕**.

The RCP window disappears and the picture of step 2 is appeared. Then after a few seconds, normal picture is restored.

Tip

There are some limitations on selection of position and range.

Using the Supplied Software to Adjust the Picture Quality (ImageDirector3)

By using the “ImageDirector3” (supplied as a CD-ROM), you can make the desired gamma correction from a computer connected to the projector. Connect the REMOTE connector of the projector with a computer and start-up “ImageDirector3” on the computer.

For details on how to use the “ImageDirector3,” refer to the Help within the CD-ROM.

Notes

- You need to install the “ImageDirector3” on a computer beforehand.
- When connecting the REMOTE connector with a computer, connect while the power of the computer and the projector is off.
- You can only perform adjustment with “ImageDirector3” when “Gamma Correction” in the Picture menu is set to Gamma 1 to 6. Adjustment is not possible when it is set to Gamma 7 to 10 and Off.
- Before using “Image Director3,” use the Picture **Ⓜ** menu to set “Gamma Correction” to Off or Gamma 1 to 6.
- If use “ImageDirector3” while a 3D video image is displayed and a 3D signal is input, the image may be distorted.

Using the Menus

This section describes how to make various adjustments and settings using the menus.

Operation through the Menus

The projector is equipped with an on-screen menu for making various adjustments and settings. Some of the adjustable/setting items are displayed in a pop-up menu, in a setting menu or adjustment menu with no main menu, or in the next menu window. If you select an item name followed by an arrow (▶), the next menu window with setting items appears.

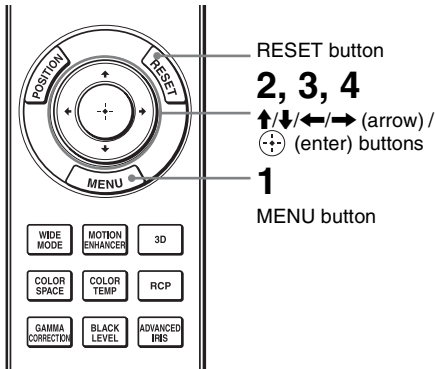

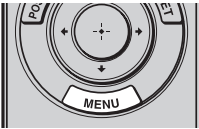

1 Press MENU.

The menu window appears.

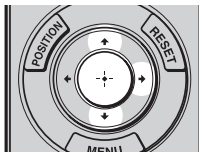
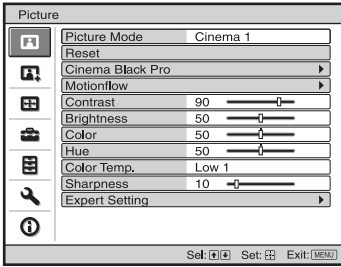

2 Press ↑/↓ to select a menu item, and press → or ⬇.

The items that can be set or adjusted with the selected menu appear. The item presently selected is shown in white.

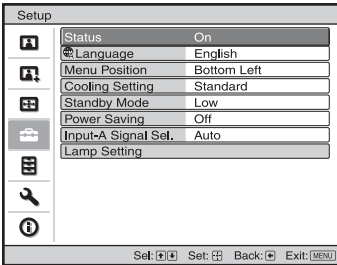

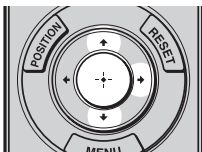

Pop-up menu

Setting items



Setting menu

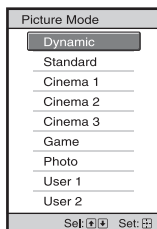

Adjustment menu

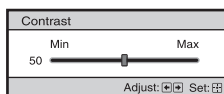

Next menu window

Setting items

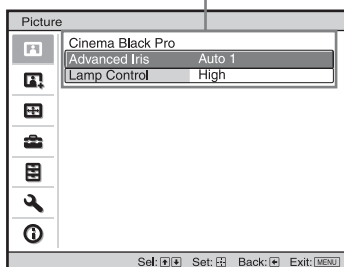

- 3** Press **↑/↓** to select an item you want to set or adjust and press **→** or **⊕**.

The setting items are displayed in a pop-up menu, in a setting menu, in an adjustment menu or in the next menu window.

4 Make the setting or adjustment of an item.

When changing the adjustment level

To increase the value, press **↑/→**.

To decrease the value, press **↓/←**.

Press **⊕** to restore the original menu screen.

When changing the setting

Press **↑/↓** to change the setting.

Press **⊕** to restore the original screen.

You can restore the original screen using **←** depending on the selected item.

Items that cannot be adjusted

Adjustable items differ depending on the input signal. The items that cannot be adjusted or set do not appear in the menu (☞ page 85).

To clear the menu

Press MENU.

To reset the picture that has been adjusted

Select “Reset” from Picture **🖼️** menu.

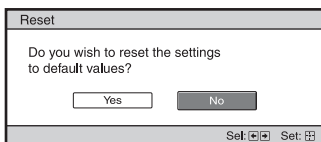

When the screen display appears, select “Yes” using **←** and press **⊕**.

All of the following settings are reset to its factory preset value.

The settings of “Cinema Black Pro,” “Motionflow,” “Contrast,” “Brightness,” “Color,” “Hue,” “Color Temp.,” “Sharpness,” and “Expert Setting” on the Picture **🖼️** menu

To reset the items that have been adjusted

Select an item in the Menu screen, and display the pop-up menu, the setting menu, and the adjustment menu.

Press the RESET on the remote control to reset only the selected settings to its factory preset value.

Note

RESET button on the remote control is available only when the adjustment menu or the setting menu is selected.

Picture Menu

The Picture menu is used for adjusting the picture.

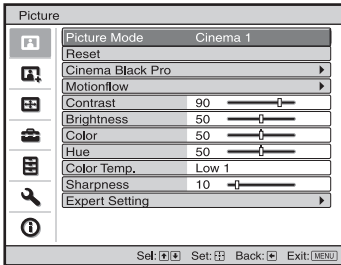

Note

These items may not be available, depending on the type of input signal. For details, see “Input Signals and Adjustable/Setting Items” (pages 85 to 88).

<p>Picture Mode</p>	<p>You can select the picture viewing mode that best suits the type of picture or the environment.</p> <p>The availability of each picture mode depends on whether the video image is 2D or 3D.</p> <p>Dynamic: Project bright images with sharp, vivid picture quality.</p> <p>Standard: Ideal for projecting TV programs, sports, concerts, and other video images.</p> <p>Cinema 1: Picture quality suited for watching movies.</p> <p>Cinema 2: Picture quality suited for digital cinema content.</p> <p>Cinema 3: Simulates production/editing studio picture quality.</p> <p>Game: Picture quality suited for playing video games.</p> <p>Photo: Ideal for projecting still images taken with a digital camera.</p> <p>User 1, User 2: You can adjust the quality of the picture to suit your taste and then store the settings. Once the settings are stored, you can view the picture with the adjusted picture quality by pressing each PICTURE MODE button on the remote control.</p> <p>Tip</p> <p>You can also store the settings if the picture quality is adjusted in other modes. To reset everything to the factory settings, select “Reset” from the menu.</p> <p>The factory default settings are as follows.</p> <p>User 1: Same as “Cinema 1” setting.</p> <p>User 2: Same as “Cinema 3” setting.</p>
<p>Reset</p>	<p>Resets all currently selected picture mode settings to their default values (page 48).</p> <p>Note</p> <p>Reset does not affect settings saved for the Custom 1 to 5 items of “Color Temp.,” or “Black Level Adj.,” or “White Level Adj.” items of “Gamma Correction.”</p>

<p>Cinema Black Pro</p>	<p>Advanced Iris Switches the iris function during projection. Auto 1: Automatically switches to an optimum iris according to a projected scene. The contrast of the scene is emphasized most. Auto 2: An optimum iris becomes smaller than when set to “Auto 1.” The contrast of the scene becomes reduced. Sensitivity: If “Auto 1” or “Auto 2” is selected, you can set the response speed that the iris is automatically switched according to a projected scene. “Recommend,” “Fast,” or “Slow” can be selected according to you desired response speed. Manual: Manually (fixed) adjusts the Iris.</p> <div data-bbox="555 384 777 475" style="text-align: center;"> <p>The image shows a horizontal slider control for manual iris adjustment. The slider is labeled 'Manual' at the top. Below the label, there are two end points: 'Min' on the left and 'Max' on the right. A vertical line with a small square knob is positioned between Min and Max, indicating the current setting. Below the slider, there are two buttons: 'Adjust: [Left Arrow] [Right Arrow]' and 'Set: [Enter]'.</p> </div> <p>Off: Disables the iris (aperture) function.</p>
<p>Motionflow</p>	<p>Film Projection Reproduces movies in its original moving picture. Mode 1: Suited for watching movies. Mode 2: Suited for watching movies and the picture is brighter than in “Mode 1.” Off: Normal picture.</p> <p>Note When you select “Mode 1” or “Mode 2” the picture will become slightly darker than in “Off.”</p>
<p>Motionflow</p>	<p>Motion Enhancer Reproduces fast-moving pictures smoothly without generating afterimages. High: Select this for picture quality smoother than “Low.” Low: Select this for smooth picture quality. Off: Select “Off” when noise, etc. appears in “High” or “Low.”</p> <p>Note Depending on the scene, a noise in particular in digital signals may appear on the picture.</p>
<p>Contrast</p>	<p>Adjusts the contrast. Higher values increase the sharpness in images, while lower values decrease the sharpness. You can make adjustments by pressing the CONTRAST+/- on the remote control.</p>

Brightness	<p>Adjusts the brightness of the picture. The higher the setting, the brighter the picture. The lower the setting, the darker the picture. You can make adjustments by pressing the BRIGHTNESS+/- on the remote control.</p>
Color	<p>Adjusts the color density. The higher the setting, the greater the intensity. The lower the setting, the lower the intensity.</p>
Hue	<p>Adjusts the color tone. The higher the setting, the more greenish the picture becomes. The lower the setting, the more reddish the picture becomes.</p>
Color Temp.	<p>Adjusts the color temperature. High: Equivalent to 9,300 K color temperature. Gives white colors a blue tint. Middle: Equivalent to 8,000 K color temperature. Gives a neutral tint between “High” and “Low.” Low 1: Equivalent to 6,500 K color temperature. Gives white colors a red tint. Low 2: Equivalent to 5,500 K color temperature. Gives white colors an even redder tint. Custom 1 to 5: Enables you to adjust, set, and store your favorite color temperature. The factory default settings are as follows. Custom 1: Same as “High” color temperature setting. Custom 2: Same as “Middle” color temperature setting. Custom 3: Same as “Low 1” color temperature setting. Custom 4: Same as “Low 2” color temperature setting. Custom 5: Setting that prioritizes brightness.</p>
Sharpness	<p>Sharpens the outline of the picture, or reduces the noise. The higher the setting, the sharper the picture. The lower the setting, the softer the picture, thus reducing the noise. You can make adjustments by pressing the SHARPNESS+/- on the remote control.</p>
Expert Setting	<p>NR (Noise Reduction) Reduces the roughness or noise of the picture. Usually, use to select “Off.” If the picture is rough or noisy, select a setting from among “Low,” “Middle” or “High” according to the input signal source.</p> <p>MPEG NR (MPEG Noise Reduction) Reduces block noise and mosquito noise, in particular in digital signals. Block NR: Reduces digital noise that appears in mosaic-like pattern. Mosquito NR: Reduces digital noise that appears near the outline of the picture.</p>

Expert Setting

Film Mode

According to the film source you have selected, make a setting for playback.

Auto 1: Suited for reproducing a picture movement close to the original picture movement of the film source. Normally, set this to "Auto 1."

Auto 2: Reproduces a 2-3 or 2-2 Pull-Down format video signal, such as film sources, in a smooth picture movement. When a video signal other than 2-3 or 2-2 Pull-Down format is input, the picture is played back in progressive format.

Off: Plays back the picture in progressive format without detecting video signals automatically.

Gamma Correction

Adjusts the response characteristics of the tone of the picture.

Select a favorite tone from 10 options.

Gamma 1: Bright Produces a brighter picture overall.

Gamma 2:

Gamma 3:

Off

Gamma 4: Dark Produces a darker picture overall.

Gamma 5: Brightens dark areas in the picture, and expands gradation expression.

Gamma 6: Produces a picture with contrast emphasized slightly.

Gamma 7: Produces a picture with contrast emphasized more than with Gamma 6.

Gamma 8: Simulates the gamma curve of film.

Gamma 9: Expands gradation expression on the black side more than with Gamma 8.

Gamma 10: Simulates the gamma curve of still images.

Off: Gamma Correction is "Off."

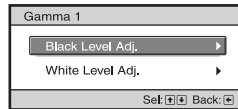

Black Level Adj. (Adjust): Produces a bolder, dynamic picture.

Set according to the input signal source.

3: Brightens dark areas in the picture, and expands gradation.

↕

-3: Emphasizes dark areas in the picture.

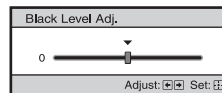

White Level Adj. (Adjust): Produces clear picture with sharp light/dark contrast.

Set according to the input signal source.

3: Makes bright areas in the picture even brighter.

↕

-3: Lowers the brilliance of bright areas in the picture.

Expert Setting	<p>Using the specified controller, “ImageDirector3” (supplied as a CD-ROM) allows you to adjust, set, and store a favorite tone in a computer. For detailed information on “ImageDirector3,” refer to the Help provided on the supplied CD-ROM in the computer.</p> <p>Note You can only perform adjustment with “ImageDirector3” when Gamma 1 to 6 are configured. Adjustment is not possible with Gamma 7 to 10 and Off.</p>
	<p>x.v.Color Set this item when playing back an x.v.Color video signal. Set this item to “On” when connecting the projector with equipment that supports x.v.Color and playing back an x.v.Color video signal. For details on x.v.Color, see “About the x.v.Color” (☞ page 68).</p>
	<p>Color Space You can convert the range of color reproduction. Normal: Color range conforming to sRGB standards. Wide 1: Reproduces color similar to film. Wide 2: Reproduces color similar to digital cinema. Wide 3: Produces a wider, more vivid range of color reproduction.</p>

Advanced Picture Menu

The Advanced Picture is used for adjusting the picture more.

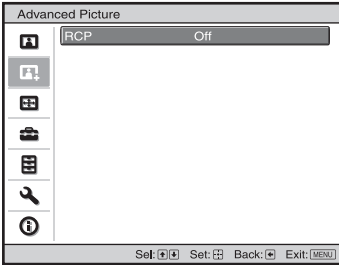

RCP (Real Color Processing)	<p>You can adjust the color, hue, and brightness of each selected portion of the picture independently.</p> <p>User 1, User 2, User 3: You can adjust the picture using Real Color Processing and store the settings. Once the settings are stored, you can view the picture with the adjusted picture quality.</p> <p>Off: Cancels this feature.</p> <p>For details, see “Adjusting the Picture Using Real Color Processing” (📖 page 43).</p>
------------------------------------	---

Screen Menu

The Screen menu is used to adjust the input signal. You can adjust the size of the picture, and select wide screen mode, etc.

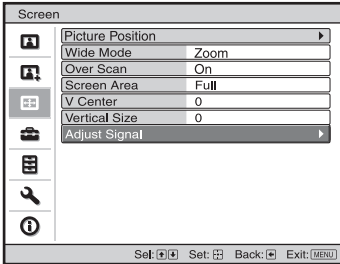

Note

These items may not be available, depending on the type of input signal. For details, see “Input Signals and Adjustable/Setting Items” (🔗 pages 85 to 88).

<p>Picture Position</p>	<p>You can store up to five lens settings. After selecting and confirming the desired position from among “Position 1” to “Position 5,” do “Save,” “Delete,” or “Select.” “Save”: Stores the current lens position in the selected “Position (1-5).” If a setting is already stored in that Position, it is overwritten. “Delete”: Deletes the stored setting. After the setting is deleted, the “Position 1” to “Position 5” in the display change to “---” “Select”: The lens position is automatically adjusted to the selected setting.</p> <p>Notes</p> <ul style="list-style-type: none"> • After you have selected and confirmed the lens position, the lens starts to move automatically. Do not touch the lens and the area around the lens, otherwise it may cause injury or a malfunction. • If you press any button on the projector while the lens is moving, the lens stops. In this case, select the lens position again or adjust the lens manually. • When you use a 2.35:1 aspect ratio picture or a 16:9 picture using the Picture Position function, make sure that the installation position is suitable (🔗 page 33). • The Picture Position function is not guaranteed to reproduce the lens settings precisely.
--------------------------------	---

<p>Wide Mode (Video signal)</p>	<p>You can set the aspect ratio of the picture to be displayed for the current input signal (🔧 page 34). This item is enabled only when a video signal (preset memory numbers 3 to 14) (🔧 pages 83) is input.</p> <p>Wide Zoom: A 4:3 aspect ratio picture is enlarged naturally to fill the screen. The upper and lower portions of the screen are slightly cut off.</p> <p>Normal: A 4:3 aspect ratio picture is displayed in the center of the screen and enlarged to fill the screen vertically.</p> <p>Full: A picture squeezed to 4:3 aspect ratio is displayed in its original aspect ratio. When a 4:3 aspect ratio picture is displayed, the picture is enlarged horizontally to fill the 16:9 screen.</p> <p>Zoom: A picture is enlarged vertically and horizontally in the same ratio to fill the screen. The upper and lower portions are cropped.</p> <p>Anamorphic Zoom: A 2.35:1 aspect ratio picture is converted to a normal 16:9 picture on the screen. This mode is best suited when using a commercially available Anamorphic lens which converts a normal 16:9 aspect ratio picture to a 2.35:1 picture (🔧 pages 8, 35). If you set “Trigger Select” on the Installation 🗑️ menu to “Anamorphic Zoom,” 12 V signals will be output from the TRIGGER connector (🔧 page 63).</p> <p>You can switch settings by pressing WIDE MODE on the remote control.</p>
<p>Wide Mode (Computer signal)</p>	<p>You can set the aspect ratio of the picture to be displayed for the current input signal (🔧 page 35). This item is enabled only when a computer signal is input.</p> <p>Full 1: Displays a picture on the whole of the screen without changing the aspect ratio of the original picture.</p> <p>Full 2: Displays a picture on the whole of the screen.</p> <p>Zoom: A picture is enlarged vertically and horizontally in the same ratio to fill the screen. The upper and lower portions are cropped.</p> <p>You can switch settings by pressing WIDE MODE on the remote control.</p> <p>Note</p> <p>When the aspect ratio of the input signal is 16:9 or wider, this setting is fixed at “Full 1.”</p>
<p>Over Scan</p>	<p>Hides the outline of the picture.</p> <p>On: Hides the outline of the input picture. Select this setting when noise appears along the edge of the picture.</p> <p>Off: Projects the whole of the input picture.</p> <p>Tip</p> <p>To display the displayable region within the four directions of the screen, refer to “Blanking” on the Installation 🗑️ menu (🔧 page 64).</p>
<p>Screen Area</p>	<p>Selects the size of the picture when a Hi-Vision picture is overscanned.</p> <p>Full: Expands the picture on the whole of the screen.</p> <p>Through: Does not expand the picture on the whole of the screen.</p>
<p>V Center</p>	<p>Adjust the whole picture by moving up and down on the screen.</p> <p>As the selected number increases, the screen moves up, and as the selected number decreases, the screen moves down.</p>

Vertical Size	<p>Reduces or enlarges the picture vertically.</p> <p>The screen is enlarged as the setting increases and reduced as the setting decreases. If the subtitle of a movie, etc. cannot be seen, use this together with “V Center.”</p>
Adjust Signal	<p>You can adjust the input signal.</p> <p>APA: Adjusts “Phase,” “Pitch,” and “Shift” automatically to a position that suits the image signal for pictures from a computer.</p> <p>Phase: Adjusts the dot phase and the phase of computer signal of pictures from a computer. Adjusts the picture to the point where it looks clearest.</p> <p>Pitch: Adjusts the horizontal size of the picture from a computer. As the number increases, the picture becomes wider, and as the number decreases, the picture becomes narrower. Adjust the setting to match the number of dots of the input signal.</p> <p>Shift: Adjusts the position of the picture.</p> <p>H: As the setting for H (horizontal) increases, the picture moves to the right, and as the setting decreases, the picture moves to the left. Use ◀ / ▶ to adjust the horizontal position.</p> <p>V: As the setting for V (vertical) increases, the picture moves up, and as the setting decreases, the picture moves down. Use ↑ / ↓ to adjust the vertical position.</p>

Setup Menu

The Setup menu is used to change the factory preset settings, etc.

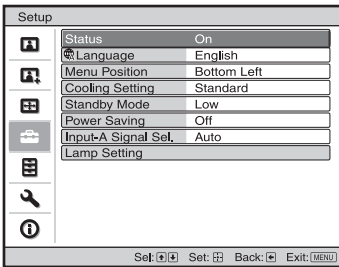

Status	<p>Sets whether or not the on-screen display is displayed. Set to “Off” to turn off the on-screen displays except for certain menus, message when turning off the power, and warning messages.</p>
Language	<p>Selects the language used in the menu and on-screen displays. Available languages are: English, Dutch, French, Italian, German, Spanish, Portuguese, Russian, Swedish, Norwegian, Japanese, Chinese (Simplified Chinese), Chinese (Traditional Chinese), Korean, Thai and Arabic.</p>
Menu Position	<p>You can change the position to display the menu on the upper screen. Bottom Left: Displays the menu on the bottom left area of the screen. Center: Displays the menu on the center of the screen.</p>
Cooling Setting	<p>Use this item when using the projector at high altitudes. High: Use this setting when using the projector at an altitude of 1,500 m or higher. Standard: Use this setting when using the projector at normal altitudes.</p> <p>Notes</p> <ul style="list-style-type: none"> • When this item is set to “High”, the fan noise becomes slightly louder since the number of fan rotations increase. • Do not use the projector at an altitude of 2,700 m or higher.
Standby Mode	<p>Lowers the power consumption in standby. When set to “Standard”, the power consumption in standby becomes normal. When set to “Low”, the power consumption in standby is lowered.</p> <p>Notes</p> <ul style="list-style-type: none"> • The factory default setting is “Low”. • When this item is set to “Low”, the “PJ Auto Power On” function is disabled (The function is set to “Off” and does not appear in the menu).

Power Saving	<p>Sets the power saving mode. When set to “On,” the projector goes into power saving mode if no signal is input for 10 minutes. At that time, the ON/STANDBY indicator lights in orange, then the screen becomes dark. In power saving mode, the power saving mode is cancelled if a signal is input or any button on the projector or the remote control is pressed. If you do not want to set the projector to power saving mode, select “Off.”</p>
Input-A Signal Sel.	<p>Selects the type of signal input from the equipment connected to the INPUT A connector. Selects the type of signal input from the equipment by selecting “Input-A” with the INPUT button. Auto: Selects the input signal type automatically. Computer: Inputs the signal from a computer. Video GBR: Inputs the signal from a TV game or HDTV broadcast. Component: Inputs the component signal from a DVD player/recorder, Blu-ray Disc player/recorder, digital tuner, etc.</p> <p>Note When the input signal is not displayed correctly with this item set to “Auto,” select the item according to the input signal.</p>
Lamp Setting	<p>When replacing the lamps, set the desired lamp setting (Ⓡ page 77).</p>

Function Menu

The Function menu is used for changing the settings of the various functions of the projector.

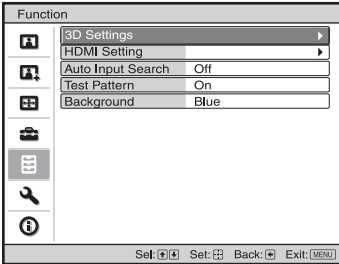

3D Settings

You can change the settings of the 3D function.

You can display the “3D settings” by pressing the 3D button on the remote control.

2D-3D Display Sel.: For Switching the video images to “2D” or “3D.”

Auto: Displays 3D video images when HDMI signals with 3D information are input. Displays 2D video images when other signals are input.

3D: Displays 3D video images according to the 3D system selected in “3D Format.” However, when HDMI signals with 3D information are input the projector, displays 3D video images according to the 3D system of the HDMI signals with 3D information.

2D: Displays 2D video images.

* The 3D information is additional information to discriminate 3D.

3D Format: Set the 3D system when the input HDMI signals do not include 3D information.

Simulated 3D: Converts 2D video images to 3D video images.

The setting can be made only for input the HD signals.

- The simulated 3D feature may have limited effect, depending on the video source.
- There are differences in perception of 3D video images among individuals.
- The projector automatically returns to 2D display after approximately one hour when displaying the 3D video images with simulated 3D.

Side-by-Side: Displays 3D images as received (before conversion to sequential) in left-right split-screen format.

Over-Under: Displays 3D images as received (before conversion to sequential) in top-bottom split-screen format.



3D Settings	<p>3D Glasses Bri'ness: For adjusting the brightness of the picture when watching 3D video images using the 3D glasses. You can select the brightness from among “Min,” “1,” “2,” “3,” and “Max.”</p> <p>3D Depth Adjust: For adjusting the depth of the 3D video images on the screen. The setting can be made only when a 3D Format other than “Simulated 3D” is selected.</p> <p style="text-align: center;"> Depth -2 -1 0 +1 +2 Front ← Normal → Depth </p> <p>We recommended that “3D Depth Adjust” be set to “0.” The 3D video images may be difficult to perceive, depending on the setting of “3D Depth Adjust.”</p> <p>Simulated 3D Effect: For adjusting the 3D effect when 2D content is converted to 3D video images. You can select the effect from among “High,” “Middle,” and “Low.”</p> <p>Notes</p> <ul style="list-style-type: none"> • The menu display has a ghost while a 3D video image is displayed and is best viewed with the 3D glasses. • We recommended that the screen size be 100 to 120 inches. If you watch 3D video images on a screen larger than 100 inches, the 3D effect may be diminished.
HDMI Setting	<p>You can change the settings of the Control for HDMI function.</p> <p>Control for HDMI: Selects the function whether to turn the Control for HDMI function effective when the HDMI 1 and HDMI 2 connectors are connected to a Control for HDMI compatible equipment.</p> <p>When set to “On,” the following are available.</p> <ul style="list-style-type: none"> • The operation of the projector and the connected Control for HDMI compatible equipment will synchronize with each other. • The Control for HDMI setting of Sony equipment (AV amplifier, video, etc.), which is compatible with “Control for HDMI - Easy Setting,”* will also be effective. <p>The factory default setting is “On.”</p> <p>Device Auto Power Off: Sets whether to also turn the power of the connected Control for HDMI compatible equipment off when you turn the power of the projector off.</p> <p>When set to “On,” the equipment will synchronize and turn off when the power of the projector turns off.</p> <p>The factory default setting is “On.”</p> <p>PJ Auto Power On: Select whether to link the power of the projector to the Control for HDMI compatible equipment.</p> <p>When set to “On,” the power of the projector will automatically turn on when the power of the connected equipment is turned on or when making operations such as playback.</p> <p>Note</p> <p>To enable this function, set “Standby Mode” (☞ page 58) on the Setup  menu to “Standard,” and then set “PJ Auto Power On” to “On.” For details, see “About the Control for HDMI” (☞ page 67).</p>

HDMI Setting	<p>Device List: Lists all the Control for HDMI compatible equipment connected to the projector.</p> <p>When “Enable” is selected, the Control for HDMI setting of Sony equipment (AV amplifier, video, etc.), which is compatible with “Control for HDMI - Easy Setting,” will also be effective.</p> <div data-bbox="486 233 902 609" style="border: 1px solid black; padding: 5px; margin: 10px auto; width: fit-content;"> <table border="1" style="width: 100%; border-collapse: collapse;"> <thead> <tr> <th colspan="3" style="text-align: left; padding: 2px;">Device List</th> </tr> <tr> <th style="text-align: left; padding: 2px;">Input</th> <th style="text-align: left; padding: 2px;">Device</th> <th style="text-align: left; padding: 2px;">Type</th> </tr> </thead> <tbody> <tr> <td style="padding: 2px;">HDMI 1</td> <td style="padding: 2px;">Player 1</td> <td style="padding: 2px;">BD</td> </tr> <tr> <td style="padding: 2px;">HDMI 2</td> <td style="padding: 2px;">Player 2</td> <td style="padding: 2px;">DVD</td> </tr> </tbody> </table> <p style="font-size: small; margin-top: 10px;">Would you like to enable for HDMI settings for connected devices? Before enabling settings, turn on the devices. For unrecognized devices, check settings on their side.</p> <p style="text-align: center; margin-top: 5px;"><input type="button" value="Enable"/></p> <p style="text-align: right; font-size: x-small; margin-top: 5px;">Set: [] Back: [MENU]</p> </div> <p>* “Control for HDMI - Easy Setting” is a function that makes the Control for HDMI setting of equipment connected to HDMI input of the projector effective as well when the Control for HDMI setting of the projector is effective. This function is only available between compatible Sony equipment, and some equipment may not be compatible.</p> <p>Although some non-Sony equipment may be compatible, operation is not guaranteed for such equipment.</p>	Device List			Input	Device	Type	HDMI 1	Player 1	BD	HDMI 2	Player 2	DVD
Device List													
Input	Device	Type											
HDMI 1	Player 1	BD											
HDMI 2	Player 2	DVD											
Auto Input Search	<p>Hides input terminals that do not have signal input.</p> <p>When set to “On,” terminals without input signals do not appear on the input palette that appears when you press INPUT.</p> <p>To display all input terminals, set this to “Off” (Ⓞ page 31).</p>												
Test Pattern	<p>Displays the test pattern.</p> <p>When set to “On,” a test pattern appears on the screen to be used when adjusting the lens with “Lens Focus,” “Lens Zoom,” and “Lens Shift,” or correcting the screen proportions with “V Keystone.” A test pattern does not appear when this item is set to “Off.”</p> <p>Tip</p> <p>While the test pattern is displayed, it is only displayed in green to allow you to adjust the focus easily.</p>												
Background	<p>Selects the background color of the screen when no signal is input.</p> <p>You can select “Black” or “Blue.”</p>												

Installation Menu

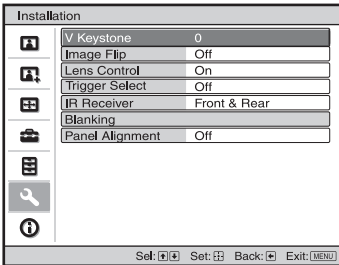
The Installation menu is used for changing the installation settings.



V Keystone	<p>Corrects the vertical trapezoidal distortion of the picture. When the bottom of the trapezoid is longer than the top (): Sets a lower value (– direction) When the top of the trapezoid is longer than the bottom (): Sets a higher value (+ direction).</p> <p>Note</p> <p>Depending on the picture position adjusted with the lens shift feature, the aspect ratio of the picture may change from the original or picture distortion may occur with V Keystone adjustment.</p>
Image Flip	<p>Flips the picture on the screen horizontally and/or vertically. HV: Flips the picture horizontally and vertically. H: Flips the picture horizontally. V: Flips the picture vertically. Off: The picture does not flip. Use this item for installation for the backside projection or ceiling installation.</p>
Lens Control	<p>Avoids any operation of the lens such as “Lens Focus,” “Lens Zoom,” and “Lens Shift,” by mistake. When set to “On,” you can adjust the projection lens using “Lens Focus,” “Lens Zoom,” and “Lens Shift.” After you make this adjustment, it is recommended that you set this item to “Off” to avoid any operation of the lens.</p>
Trigger Select	<p>For Switching the output of the TRIGGER connector. Off: Turns off the TRIGGER connector feature. Power: Outputs 12V signals from the TRIGGER connector when the projector is on. The TRIGGER connector does not output any signals when the projector is off. Anamorphic Zoom: Outputs 12V signals when “Wide Mode” is set to “Anamorphic Zoom” (Ⓞ page 56). The TRIGGER connector does not output any signals when “Wide Mode” is set to other than “Anamorphic Zoom.”</p>

<p>IR Receiver</p>	<p>Selects the remote control detectors (IR Receiver) on the front and rear of the projector. Front & Rear: Activates both the front and rear detectors. Front: Activates the front detector only. Rear: Activates the rear detector only.</p>
<p>Blanking</p>	<p>This feature allows you to adjust the displayable region within the four directions of the screen. Select the edge to adjust by highlighting Left, Right, Top, or Bottom using the ↑ / ↓ buttons. Adjust the amount of blanking using the ← / → buttons.</p> <div data-bbox="557 371 829 528" data-label="Image"> <p>The screenshot shows a menu titled "Blanking" with four rows: "Left: 2", "Right: 3", "Top: 2", and "Bottom: 3". At the bottom of the menu are three buttons: "Set: [OK]", "Adjust: [Left/Right]", and "Set: [Exit]".</p> </div> <p>Note</p> <p>When both the “Blanking” and the “V Keystone” are adjusted at the same time, the “Blanking” cannot be adjusted correctly. When using the “Blanking,” make sure that you set the “V Keystone” to “0.”</p>

Panel Alignment

This feature allows you to adjust the gaps in the color of characters or the picture.

When set to “On,” “Adjust Color” and “Pattern Color” can be assigned and adjusted.

Adjust Item: Selects how to make adjustments from below.

Shift: Shifts the whole picture and makes adjustments.

Zone: Selects the desired range and makes adjustments.

Adjust Color: Assigns the desired color to adjust the gaps in color. Select “R” (Red) or “B” (Blue) to make adjustments based on “G” (Green).

Pattern Color: Select “R/G” (Red and Green) or “R/G/B” (White, all colors) when “Adjust Color” is “R” (Red). Select “B/G” (Blue and Green) or “R/G/B” (White, all colors) when the “Adjust Color” is “B” (Blue).

Adjust: The shift adjustment and zone adjustment of the color selected in “Adjust Color” can be made with ← / →, ↑ / ↓ buttons.

When “Shift” is selected: Assign the settings of the horizontal direction (H) with ← / → buttons and the vertical direction (V) with ↑ / ↓ buttons on the shift adjustment screen.

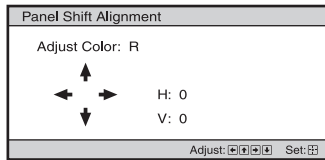

When “Zone” is selected: Select the position to adjust with ← / → buttons for the horizontal position (H position) and ↑ / ↓ buttons for the vertical position (V position), then press Ⓢ.

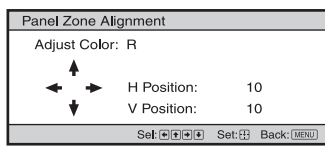

Set the amount to adjust with ← / → buttons for the horizontal direction (H direction) and with ↑ / ↓ buttons for the vertical direction (V direction). You can select the position to adjust again by pressing Ⓢ.

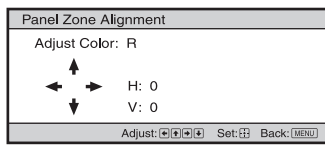

Reset: Returns to the factory settings.

Note

Depending on the adjustments made above, colors may become uneven or the resolution may change.

Information Menu

The Information menu displays the model name, serial number, the horizontal and vertical frequencies of the input signal and the cumulated hours of usage of the lamp.

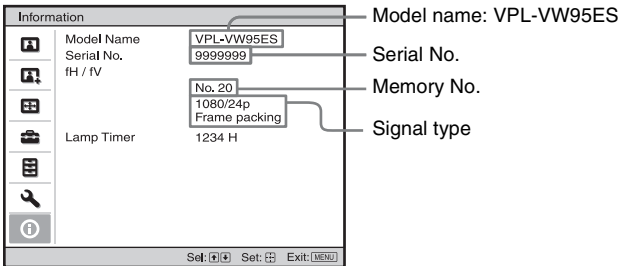



Model name	Displays the model name (VPL-VW95ES).
Serial No.	Displays the serial number.
fH (horizontal frequency)	Displays the horizontal frequency of the input signal.
fV (vertical frequency)	Displays the vertical frequency of the input signal.
Memory No.	Displays the preset memory number of the input signal.
Signal type	Displays the type of the input signal. When input signals with 3D information are input, the type of input signals and the 3D format are displayed.
Lamp Timer	Indicates how long the lamp has been turned on (total usage).

Notes

- fH (horizontal frequency) and fV (vertical frequency) may not be displayed depending on the input signal used on the projector.
- You cannot change the displays listed above.

About the Preset Memory No.

This projector has 32 types of preset data for input signals (the preset memory). When the preset signal is input, the projector automatically detects the signal type and recalls the data for the signal from the preset memory to adjust it to an optimum picture. The memory number and signal type of that signal are displayed in the Information  menu.

You can also adjust the preset data through the Screen  menu.

This projector also contains 20 different user memories beside the preset memories used for inputting analog computer signals. You can save input signals that have not been preset on these user memories.

When an unpreset signal is input for the first time, a memory number is displayed as 0.

When you adjust the data of the signal in the Screen  menu, it will be registered to the projector. If more than 20 user memories are registered, the newest memory always overwrites the oldest one.

See the chart on page 83 to find if the signal is registered to the preset memory.

Note

When the aspect ratio of input signal does not match the screen size, a part of the screen is displayed in black.

This section describes about the other functions, how to solve the problems, how to replace the lamp and air filter, etc.

About the Control for HDMI

What is the Control for HDMI?

Control for HDMI is an HDMI standard mutual control function which uses the HDMI CEC (Consumer Electronics Control) specification. By connecting a variety of Control for HDMI compatible equipment such as a hard disk Blu-ray Disc player, a DVD player/recorder, an AV amplifier, etc. to a Sony Control for HDMI compatible TV or a projector with an HDMI cable, the equipment connected will synchronize with the TV or the projector when either is operated.

Using the Control for HDMI function

- Connect and assign the settings of each equipment appropriately.
- Do not turn off the main power of the equipment.
- Set the input setting of the projector to the HDMI input which the equipment is connected.
- Check if the picture from the equipment appears appropriately on the projector.

Connecting a Control for HDMI compatible equipment

Use an HDMI cable to connect the projector and the Control for HDMI compatible equipment. Use a cable that has acquired the HDMI logo.

Setting the Control for HDMI

Be sure to assign the appropriate connections for both the projector and the Control for HDMI compatible equipment

connected to the projector. For settings of the projector, see page 61. For settings of the Control for HDMI compatible equipment connected to the projector, refer to its operational instructions. When a equipment that is compatible with the “Control for HDMI - Easy Setting” is connected to the HDMI input of the projector, if you turn the Control for HDMI function setting of the projector on, the Control for HDMI function setting of the connected equipment will also turn on.

What you can do with the Control for HDMI

- By turning on or playing back the connected equipment, the projector will turn on and the input setting will switch to the terminal of the connected equipment automatically.
- By turning the power of the projector off, the power of the connected equipment will also turn off automatically.
- By changing the language setting of the projector, the language setting of the connected equipment will also change to the same language automatically.

Notes

- The available functions of the Control for HDMI differ depending on each equipment. Refer to the operating instruction of each equipment.
- Some synchronization may be available with equipment of other brands with similar functions, but it is not guaranteed.

About the x.v.Color

- “x.v.Color” is a promotion name given to the products that have the capability to realize a wide color space based on the xvYCC specifications and is a trademark of Sony Corporation.
- xvYCC is an international standard of the technical specifications of the extended-gamut color space for video signals. The color gamut of xvYCC is wider than the one of sRGB that is used with the current television system.

About the simulated 3D feature

- Use the simulated 3D function taking into account that the picture will provide a different look from the original images, because this function converts the video images.
- Note that if the projector is used for profit or for public viewing, displaying 2D video images as 3D video images by converting to the simulated 3D may constitute an infringement of the rights of authors or producers, which are legally protected.





Troubleshooting

If the projector appears to be operating erratically, try to diagnose and correct the problem using the following instructions. If the problem persists, consult with qualified Sony personnel.

Power

Symptom	Cause and Remedy
The power is not turned on.	<ul style="list-style-type: none"> → The power may not turn on if you turn the power off with I/⏻ (ON/STANDBY) switch and turn it on again in a short time. After about 1 minute, turn the power on. → Close the lamp cover securely, then tighten the screws securely (☞ page 76). → Close the filter holder securely (☞ page 77). → Check warning indicators (☞ page 72).

Picture

Symptom	Cause and Remedy
No picture.	<ul style="list-style-type: none"> → Check that the proper connections have been made (☞ page 25). → Select the input source correctly using the INPUT button (☞ page 31). → Set the computer signal to output from an external monitor. → Set the computer signal to output only to an external monitor. → Select “Computer,” “Component,” or “Video GBR” for “Input-A Signal Sel.” on the Setup  menu according to the input signal (☞ page 59).
The picture from the INPUT A connector is colored strange.	<ul style="list-style-type: none"> → Select “Computer,” “Component,” or “Video GBR” for “Input-A Signal Sel.” on the Setup  menu according to the input signal (☞ page 59).
The picture has ghosts.	<ul style="list-style-type: none"> → Video images are displayed in 3D. Watch the 3D video images using the 3D glasses, and set “2D-3D Display Sel.” to “3D” (☞ page 60).
The bright area of the picture may become unclear or texts may become faded. (When HDMI video signal is input)	<ul style="list-style-type: none"> → This symptom may occur when a signal other than those of HDMI standard is input (☞ page 32). Switch the RGB dynamic range of the connected equipment to Limited (16-235). If this adjustment is unavailable, adjust “Brightness,” “Contrast,” or “Sharpness” on the Picture  menu of the projector (☞ pages 50, 51).
The texts may become faded when connected with a computer. (When computer signal is input)	<ul style="list-style-type: none"> → This symptom may occur when a signal other than those of HDMI standard is input (☞ page 32). Adjust “Sharpness” on the Picture  menu (☞ page 51).
The picture is too dark.	<ul style="list-style-type: none"> → Adjust “Contrast” or “Brightness” on the Picture  menu properly (☞ pages 50, 51).

Symptom	Cause and Remedy
The picture is not clear.	<ul style="list-style-type: none"> → Adjust the focus (🔍 page 21). → Condensation has accumulated on the lens. Leave the projector for about 2 hours with the power on.
The picture flickers.	<ul style="list-style-type: none"> → For pictures from a computer, activate “APA” and adjust the current input signal. → Adjust “Phase” for “Adjust Signal” on the Screen 🖥️ menu properly (🔍 page 57).
The color of characters or the picture is not appropriate.	<ul style="list-style-type: none"> → Select the desired color registration in “Panel Alignment” of Installation 🛠️ menu (🔍 page 65).
Image is left on the screen. (image retention)	<ul style="list-style-type: none"> → When high contrast non-moving images are displayed for a long period of time, there may be some image retention on the screen. This is only a temporary condition. Turning off the power for a while will eliminate the retained image.

On-screen display

Symptom	Cause and Remedy
On-screen display does not appear.	<ul style="list-style-type: none"> → Set “Status” on the Setup 🛠️ menu to “On” (🔍 page 58). → Check if the ON/STANDBY indicator should light in green. When the ON/STANDBY indicator blinks in green, the projector is starting up. Wait until it stops blinking and remains lit in green.
The model name does not disappear from the screen. Or else, the demo mode is displayed continuously.	<ul style="list-style-type: none"> → The display mode of the projector may be set at the time of purchase. Consult with your local dealer or qualified Sony personnel.
Input terminals do not appear.	<ul style="list-style-type: none"> → Set “Auto Input Search” on the Function 🖥️ menu to “Off” (🔍 page 62).

Remote control

Symptom	Cause and Remedy
The remote control does not work.	<ul style="list-style-type: none"> → Batteries could be weak. Replace them with new batteries (🔍 page 11). → Insert the batteries with the correct polarities (🔍 page 11). → If there is a fluorescent lamp near the remote control detector, the projector may work improperly or inadvertently. → If you use the optional 3D Sync Transmitter and point it to the remote control detector of the unit, the remote control may not work properly. → Confirm the position of the remote control detector on the projector (🔍 page 8). → Set “IR Receiver” to “Front & Rear” on the Installation 🛠️ menu (🔍 page 64).

3D video images

Symptom	Cause and Remedy
The video image does not seem like 3D video images.	<ul style="list-style-type: none"> → Check if the 3D glasses are turned on (☞ page 39). → Make sure that the battery in the 3D glasses is charged. → Check if the input source is HDMI. → Set “2D-3D Display Sel.” to “Auto” or “3D” (☞ page 60). → Check if the input signals are compatible 3D signals (☞ page 87). → If no 3D signal is input from the 3D equipment connected to the projector, restarting the connected 3D equipment may solve the problem. → When the viewing or projector position is too far from the screen, the 3D glasses may not be able to display the images properly (☞ page 39). → If you use the optional 3D Sync Transmitter, check that it is placed within the specified range (☞ page 28). → The screen size is not appropriate. Set the zooming magnification to low or watch the image from farther away from the screen (☞ page 90).

Others

Symptom	Cause and Remedy
The fan is noisy.	<ul style="list-style-type: none"> → Check the setting of “Cooling Setting” on the Setup  menu (☞ page 58). → Make sure that the room temperature is not too high. → Check the installation conditions (☞ page 13). The number of fan rotation increases to maintain the product reliability of the projector’s components in a room, where the temperature is higher than normal. The fan noise becomes slightly louder. The approximate normal temperature is 25°C.
The lens shift cannot be adjusted.	<ul style="list-style-type: none"> → The lens shift cannot be adjusted over the range of movement. Adjust the lens shift within the range of movement (☞ pages 16, 24).
The projector and connected equipment turn On/Off, play back, and operate at the same time.	<ul style="list-style-type: none"> → “Control for HDMI,” “Device Auto Power Off,” and “PJ Auto Power ON” are set to “On.” Set them to “Off.” For details, see “HDMI Setting” (☞ page 61).

Warning Indicators

The ON/STANDBY or LAMP/COVER indicator lights up or flashes if there is any trouble with your projector.

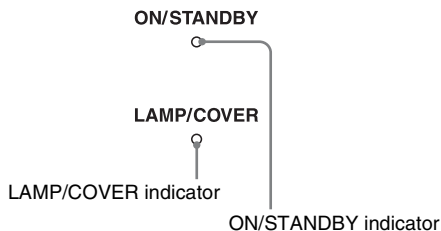

Symptom	Cause and Remedy
LAMP/COVER flashes in red. (A repetition rate of 2 flashes)	<ul style="list-style-type: none"> → Close the lamp cover securely, then tighten the screws securely (☞ page 76). → Close the filter holder securely (☞ page 77).
LAMP/COVER flashes in red. (A repetition rate of 3 flashes)	<ul style="list-style-type: none"> → The lamp has reached the end of its useful lifespan. Replace the lamp (☞ page 75). → The lamp has reached a high temperature. Wait until the lamp cools, and then turn on the power again.
ON/STANDBY flashes in red. (A repetition rate of 4 flashes)	<ul style="list-style-type: none"> → The fan is broken. Consult with qualified Sony personnel.
ON/STANDBY flashes in red. (A repetition rate of 2 flashes)	<ul style="list-style-type: none"> → The internal temperature is unusually high. Check to ensure that if nothing is blocking the ventilation holes or whether or not the projector is being used at high altitudes.
ON/STANDBY flashes in red. (A repetition rate of 6 flashes)	<ul style="list-style-type: none"> → Press the I/⏻ (ON/STANDBY) switch to turn on the projector. If the power is not turned on, disconnect the AC power cord, then confirm the ON/STANDBY lamp is turned off. After about 10 seconds, reconnect the AC power cord and turn on the power again. If the indicators still light up, the electrical system has a problem. Consult with qualified Sony personnel.

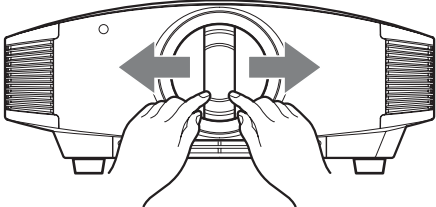
Symptom	Cause and Remedy
ON/STANDBY flashes in red. (A repetition rate of 5 times)	<p>→ The lens protector is not fully open. Turn the power of the projector off and then on again. If the lens protector still does not fully open, consult with qualified Sony personnel.</p> <p>Tip In an urgent situation, refer to the illustration below to open the lens protector with your hands. Press the I/⏻ (ON/STANDBY) switch to turn the power on and operate the projector.</p> 

Note

When a warning indicator other than the above starts flashing, and the symptom persists even after carrying out the above methods, consult with qualified Sony personnel.

Message Lists

Warning messages

Message	Cause and Remedy
High temp.! Lamp off in 1 min.	<p>→ Turn off the power.</p> <p>→ Check to ensure that nothing is blocking the ventilation holes (☞ page 14).</p>
Frequency is out of range!	<p>→ Frequency is out of range. Input a signal that is within the acceptable frequency range of the projector (☞ page 83).</p>
Please check Input-A Signal Sel.	<p>→ Set “Input-A Signal Sel.” on the Setup  menu to “Computer” when an RGB signal is input from a computer (☞ page 59).</p>
Please replace the Lamp/ Filter.	<p>→ It is time to replace the lamp. Replace the lamp (☞ page 75).</p> <p>→ Also, replace the air filter too. Restart cleaning the ventilation holes (intake) (☞ page 75).</p> <p>If this message appears again after you replace the lamp and filter, the lamp replacement process is not complete. Check the lamp replacement process (☞ page 75).</p> <p>Note To clear this message, press any button either on the remote control or the control panel of the projector once.</p>

Message	Cause and Remedy
Please clean the filter.	<p>→ It is time to clean the air filter. Clean the air filter (☞ page 78).</p> <p>Note</p> <p>To clear this message, press any button either on the remote control or the control panel of the projector once.</p>
Please clean the filter. Have you finished? Yes No	<p>→ It is time to clean the air filter. Clean the air filter (☞ page 78).</p> <p>→ If you cleaned the air filter, select “Yes.” If you did not clean the air filter, select “No.”</p>
Projector temperature is high. Cooling Setting should be “High” if projector is being used at high altitude.	<p>→ Check to ensure that the ventilation holes on the unit are not covered (☞ page 14).</p> <p>→ When using the projector at high altitude, set “Cooling Setting” to “High” (☞ page 58).</p> <p>Note</p> <p>When temperature inside the projector remains high, “Cooling Setting” is switched to “High” in 1 minute, then the fan speed increases.</p>

Caution messages

Message	Cause and Remedy
x(→)	<p>→ No signal is input in the selected input. Check connections (☞ page 25).</p>
Not applicable!	<p>→ Press the appropriate button.</p> <p>→ The operation to be activated by the button is currently prohibited.</p>

Replacing the Lamp and the Air Filter and Cleaning the Ventilation Holes (intake)

Tools you need to get started:

- Projector Lamp LMP-H202 (Optional)
- Standard Phillips screwdriver
- Cloth (for scratch protection)

The lamp used for the light source has a certain lifespan. When the lamp dims, the color balance of the picture becomes strange, or “Please replace the Lamp/Filter.” appears on the screen, the lamp may be exhausted. Replace the lamp with a new one (not supplied) without delay.

Use an LMP-H202 Projector Lamp as the replacement lamp.

The air filter is supplied with the LMP-H202 Projector Lamp. When you replace the lamp, it is also time to replace the air filter.

Whenever you replace the lamp, be sure to replace the air filter with a new one. Also clean the ventilation holes (intake).

Caution

- The lamp remains hot after the projector is turned off with the I/⏻ (ON/STANDBY) switch. If you touch the lamp, you may burn your fingers. When you replace the lamp, wait for at least 1 hour for the lamp to cool.
- Do not touch the surface of the lens. If you touch it, wipe off the fingerprints with a soft cloth.
- Pay special attention to replacing the lamp when the projector is installed on the ceiling.
- When removing the lamp unit, make sure it remains horizontal, then pull straight up. Do not tilt the lamp unit. If you pull out the lamp unit while tilted and if the lamp breaks, the pieces may scatter, causing injury.
- When you remove the air filter, be careful not to let any dust fall into the projector.
- Replacing the air filter is crucial to maintain the good performance of the projector or to prevent malfunction to it. When a warning

message for replacing the air filter appears, replace the air filter immediately.

- 1 Turn off the projector and unplug the AC power cord.
- 2 When setting the projector on a flat surface such as a desk etc., put a cloth to prevent the surface from being scratched. Reverse the projector as illustrated, then place it on the cloth.

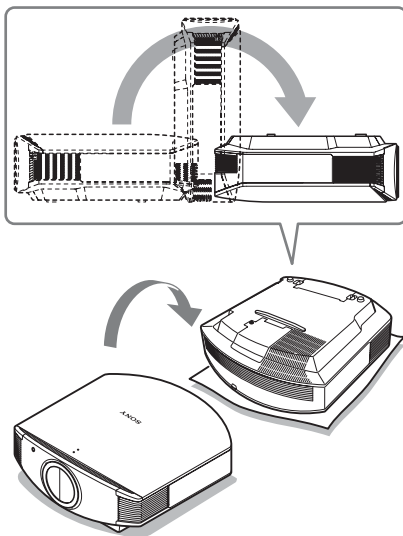

Notes

- When the lamp is damaged the broken pieces of the lamp may become scattered, if you do not reverse the projector. This may cause injury.
- Be sure that the projector is placed on a stable surface.

- 3** Loosen the screw on the lamp cover with a Phillips screwdriver, and then open the lamp cover.

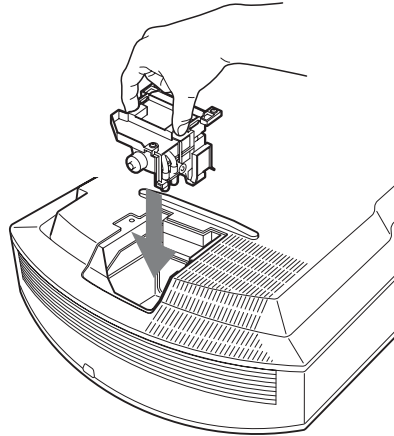
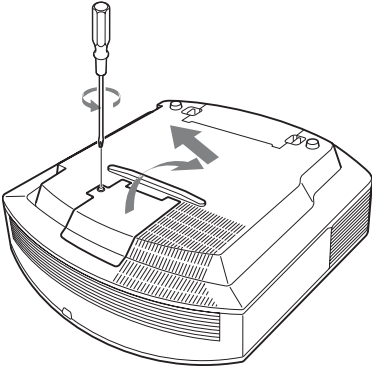

- 4** Loosen the 3 screws on the lamp with the Phillips screwdriver. Hold up the handle, then pull the lamp straight out.

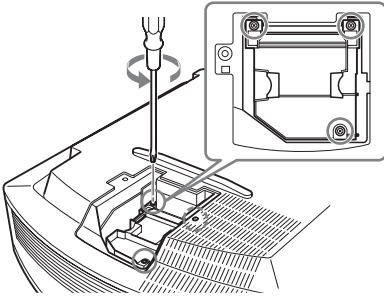

Note

Be careful not to touch the optical block inside the unit.

- 6** Close the lamp cover, then tighten the screws.

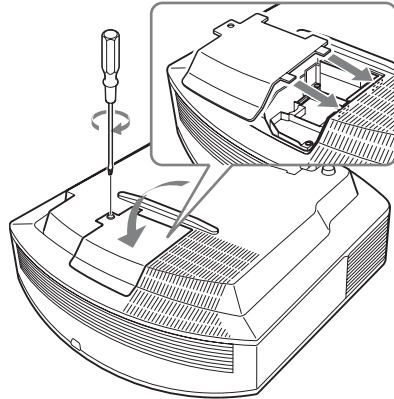

- 5** Hold the handle of the new lamp and push it in securely until it reaches the end, and then tighten the 3 screws.

7 Remove the filter holder.

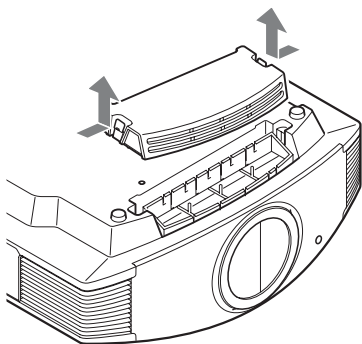

8 Remove the air filter.

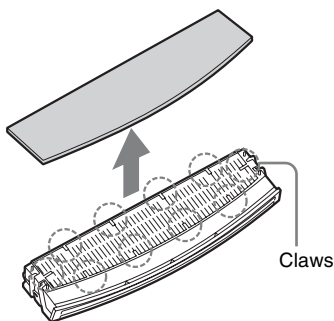

9 Attach the new air filter so that it fits into the each claws (10 positions) on the filter holder.

Note

Attach the air filter aligning it with the shape of the filter holder.
Also, do not touch the fan after removing the air filter that is set deep inside the projector.

10 Attach the filter holder.

Note

The projector will not turn on unless the filter holder is securely closed.

11 Wipe dust off the ventilation holes (intake) with a soft cloth.

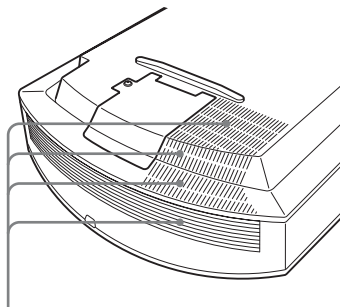

Ventilation holes (intake)

12 Place the project back on its original position.

13 Turn on the projector, then select the desired setting item on the Setup menu. The menu screen below will be appeared.

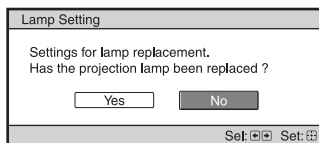

14 Select "Yes."

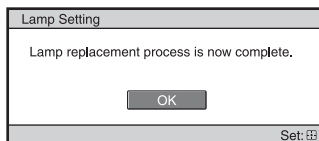

Caution

Do not put your hands into the lamp replacement slot, and do not allow any liquid or other objects into the slot to avoid electrical shock or fire.

Notes

- Be sure to use an LMP-H202 Projector Lamp for replacement. If you use lamps other than the LMP-H202, the projector may malfunction.

- Be sure to turn off the projector and unplug the power cord before replacing the lamp, then check the ON/STANDBY indicator has already been turned off.
- The projector will not turn on unless the lamp is securely installed in place.
- The projector will not turn on unless the lamp cover are securely closed.
- To cancel a message displayed on the screen, press either the button on the remote control or the one on the control panel on the projector.

Note

The lamp contains mercury. The disposal rules for used fluorescent tubes depend on where you live. Follow the waste disposal policy in your area.

Disposal of the used lamp

For the customers in the USA

Lamp in this product contains mercury. Disposal of these materials may be regulated due to environmental considerations. For disposal or recycling information, please contact your local authorities or the Telecommunications Industry Association (www.eiae.org).

Cleaning the Air Filter

When “Please clean the filter.” appears on the screen, you should clean the air filter. The air filter should be cleaned every 1,500 hours. This value varies depending on the environment or how the projector is used. 1,500 hours are approximate. After washing the air filter with a mild detergent solution, dry it in a shaded place.

Notes

- When you clean the air filter, make sure you do not damage it. For details on how to attach and remove the air filter, see “Replacing the Lamp and the Air Filter and Cleaning the Ventilation Holes (intake)” Steps 7 to 10 (☞ page 77).
- When you remove the air filter, be careful not to let any dust fall into the projector.
- Cleaning the air filter is crucial to maintain the good performance of the projector or to prevent malfunction to it. When a warning message for cleaning the air filter appears, clean the air filter immediately.

Cleaning and the Screen of the Projector

Cleaning the cabinet

- To remove dust from the cabinet, wipe gently with a soft cloth. If dust is persistent, wipe with a soft cloth slightly moistened with a diluted mild detergent solution.
- Never use any type of abrasive pad, alkaline/acid cleaner, scouring powder, or volatile solvent, such as alcohol, benzene, thinner or insecticide.
- Using such materials or maintaining prolonged contact with rubber or vinyl materials may result in damage to the screen surface and cabinet material.

Black points and bright points (red, blue, or green) on the screen

The projector is manufactured using high-precision technology.

You may, however, see tiny black points and/or bright points (red, blue, or green) that continuously appear on the projector.

This is a normal result of the manufacturing process and does not indicate a malfunction.

How to Use the USB Charging AC Power Adaptor

Use the provided USB charging AC power adaptor to charge your 3D glasses.

Caution

Connect the USB charging cable supplied with the unit, to the supplied USB charging AC power adaptor only.

Using any other connector may cause fire, a rise in temperature or damage to the cable and glasses.

- 1 Turn off the power of the 3D glasses.**
- 2 Open the 3D glasses cover and connect the USB charging cable supplied with the unit.**

Open the cover.

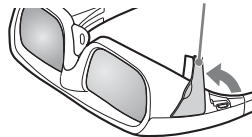

Supplied USB cable

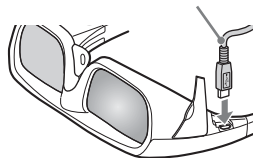

3 Connect the USB cable to the USB connector of the supplied USB charging AC power adaptor.

Supplied USB charging AC power adaptor

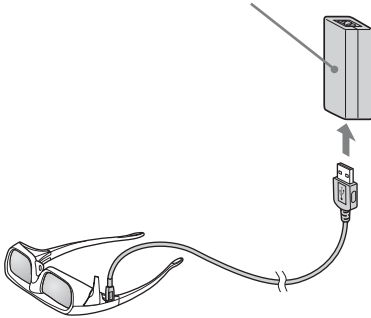

4 Connect the AC power cord for USB charging AC power adaptor to the supplied USB charging AC power adaptor.

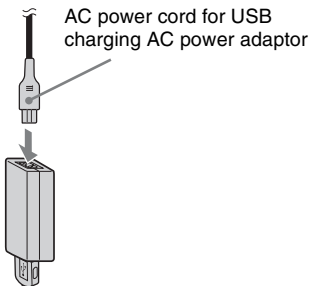

5 Plug the AC power cord for USB charging AC power adaptor into an AC outlet.

Charging starts. The LED indicator on the 3D glasses lights up in orange while the glasses are being charged.

Precautions about USB charging AC power adaptor

Installation

Do not place the USB charging AC power adaptor in a location where it is:

- Subject to extreme high temperature (E.g., in a car with its windows closed)
- Subject to direct sunlight or near a heat source
- Subject to mechanical vibration or shock

Operation

- To prevent damage, be careful not to drop or otherwise cause a mechanical shock to the unit.
- After using, disconnect the unit from the AC outlet and the equipment.
- Disconnect the unit from the AC outlet by pulling on the plug. Do not pull on the cord.
- To avoid short-circuiting, do not allow the terminals of the USB charging AC power adaptor or connector to touch any metal object.

Cleaning

- Clean the unit with a soft, dry cloth. If the unit is very dirty, wipe it off with a soft cloth lightly moistened with a mild detergent solution, and then wipe with a soft dry cloth.
- Do not use any type of solvent such as alcohol, thinner, or benzine as it may damage the finish of the cabinet.
- If you use any chemical cleaner, observe the instructions provided with the product.
- If the cabinet of the unit is splashed with any type of solvent such as insecticide, or remains in contact for a long time with rubber or vinyl, the finish of the cabinet may be damaged.

Specifications

System

Projection system	SXRD panel, 1 lens, projection system
LCD panel	0.61-inch (15.4 mm) SXRD panel 6,220,800 pixels (2,073,600 pixels × 3)
Lens	1.6 times zoom lens (motorized) f=18.5 mm to 29.6 mm F2.50 to F3.40
Lamp	200 W Ultra High Pressure Lamp
Projection picture size	40 inches to 300 inches (1,016 mm to 7,620 mm) (measured diagonally)
Acceptable video signals	15 kHz RGB/component 50/60 Hz, Progressive component 50/60 Hz, 480/60i, 576/50i, 480/60p, 576/50p, 720/60p, 720/50p, 1080/60i, 1080/50i, 1080/24PsF (48i), 1080/60p (HDMI input only), 1080/50p (HDMI input only), 1080/24p (HDMI input only), Composite video
Acceptable computer signals	fH: 19 kHz to 72 kHz fV: 48 Hz to 92 Hz Maximum resolution 1,920 × 1,080 (HDMI input only) For details, see "Preset Signals" (☞ page 83).

Input/Output

Y P _B /C _B P _R /C _R	Component: phono type Y with Sync: 1 V _p -p±2 dB sync negative (75 ohms terminated) P _B /C _B : 0.7 V _p -p±2 dB (75 ohms terminated) P _R /C _R : 0.7 V _p -p±2 dB (75 ohms terminated)
HDMI	Digital RGB/Y C _B (P _B) C _R (P _R)
INPUT A	HD D-sub 15-pins Analog RGB/component: R/C _R (P _R): 0.7 V _p -p±2 dB (75 ohms terminated) G: 0.7 V _p -p±2 dB (75 ohms terminated) G with sync/Y: 1 V _p -p±2 dB sync negative (75 ohms terminated) B/C _B (P _B): 0.7 V _p -p±2 dB

	(75 ohms terminated) SYNC/HD: Composite sync input: TTL level, positive/negative Horizontal sync input: TTL level, positive/negative VD: Vertical sync input: TTL level, positive/negative
3D SYNC	RJ45 connector
IR IN	Minijack
TRIGGER	Minijack Output impedance 1 kilohms When "Trigger Select" is set to "Power" Power on: DC 12 V Power off: 0 V When "Trigger Select" is set to "Anamorphic Zoom" Anamorphic Zoom: DC 12 V Other Wide Mode or Power off: 0 V
REMOTE	RS-232C: D-sub 9-pins (female)

General

Dimensions	470 mm × 179.2 mm × 484.9 mm (18 ¹ / ₂ × 7 ¹ / ₁₆ × 19 ³ / ₃₂ inches) (w/h/d)
Mass	Approx. 11 kg (24 lb 4.0 oz)
Power requirements	AC 100 V to 240 V, 3.0 A to 1.3 A, 50/60 Hz
Power consumption	Max. 300 W Standby mode: 8 W Standby mode (low): 0.5 W
Operating temperature	5°C to 35°C (41°F to 95°F)
Operating humidity	35% to 85% (no condensation)
Storage temperature	-20°C to +60°C (-4°F to +140°F)
Storage humidity	10% to 90%

Supplied accessories

Remote control RM-PJ21(1)
Size AA (R6) manganese batteries (2)
AC power cord (1)
Operating Instructions (1)
CD-ROM (ImageDirector3) (1)
3D glasses (2)
Pouch for the 3D glasses (2)

Preset Signals

The following table shows the signals and video formats which you can project using this unit.

When a signal other than the preset signal shown below is input, the picture may not be displayed properly.

Memory No.	Preset signal (resolution)		fH (kHz)	fV (Hz)	Sync	H Size
3	480/60i	480/60i (720 × 480i)	15.734	59.940	SonG/Y or composite sync	–
4	576/50i	576/50i (720 × 576i)	15.625	50.000	SonG/Y or composite sync /composite video	–
5	480/60p	480/60p (Progressive NTSC) (720 × 480p)	31.470	60.000	SonG/Y	–
6	576/50p	576/50p (Progressive PAL) (720 × 576p)	31.250	50.000	SonG/Y	–
7	1080/60i	1035/60i (1920 × 1035i) 1080/60i (1920 × 1080i)	33.750	60.000	SonG/Y	–
8	1080/50i	1080/50i (1920 × 1080i)	28.130	50.000	SonG/Y	–
9	1080/24PsF (48i)	1080/24PsF (48i) (1920 × 1080i)	27.000	48.000	SonG/Y	–
10	720/60p	720/60p (1280 × 720p)	45.000	60.000	SonG/Y	–
11	720/50p	720/50p (1280 × 720p)	37.500	50.000	SonG/Y	–
12	1080/60p	1080/60p (1920 × 1080p)	67.500	60.000	–	–
13	1080/50p	1080/50p (1920 × 1080p)	56.260	50.000	–	–
14	1080/24p	1080/24p (1920 × 1080p)	26.973	23.976	–	–
18	720/60p (Frame packing)	720/60p (1280 × 720p)	90.000	60.000	–	–
19	720/50p (Frame packing)	720/50p (1280 × 720p)	75.000	50.000	–	–
20	1080/24p (Frame packing)	1080/24p (1920 × 1080p)	53.946	23.976	–	–

Memory No.	Preset signal (resolution)		fH (kHz)	fV (Hz)	Sync	H Size
26	640 × 480	VESA 60	31.469	59.940	H-neg, V-neg	800
28		VESA 72	37.861	72.809	H-neg, V-neg	832
29		VESA 75 (IBM M3)	37.500	75.000	H-neg, V-neg	840
30		VESA 85 (IBM M4)	43.269	85.008	H-neg, V-neg	832
31	800 × 600	VESA 56	35.156	56.250	H-pos, V-pos	1024
32		VESA 60	37.879	60.317	H-pos, V-pos	1056
33		VESA 72	48.077	72.188	H-pos, V-pos	1040
34		VESA 75 (IBM M5)	46.875	75.000	H-pos, V-pos	1056
35		VESA 85	53.674	85.061	H-pos, V-pos	1048
37	1024 × 768	VESA 60	48.363	60.004	H-neg, V-neg	1344
38		VESA 70	56.476	70.069	H-neg, V-neg	1328
39		VESA 75	60.023	75.029	H-pos, V-pos	1312
45	1280 × 960	VESA 60	60.000	60.000	H-pos, V-pos	1800
47	1280 × 1024	VESA 60	63.974	60.013	H-pos, V-pos	1696
50	1400 × 1050	SXGA +	65.317	59.978	H-neg, V-pos	1864
55	1280 × 768	1280 × 768/60	47.776	59.870	H-neg, V-pos	1664
56	1280 × 720	1280 × 720/60	44.772	59.855	H-neg, V-pos	1664

Preset memory numbers for each input signal

Analog signal

Signal	Preset memory number
Component signal (INPUT A and Y/Cb/Pb/CR/PR connectors)	3 to 11
Video GBR signal (INPUT A connector)	3 to 11
Computer signal (INPUT A connector)	26, 28 to 35, 37 to 39, 55, 56

Digital signal

Signal	Preset memory number
Component signal (HDMI 1, 2 connectors)	3 to 8, 10 to 14, 18 to 20
Video GBR signal (HDMI 1, 2 connectors)	3 to 8, 10 to 14, 18 to 20
Computer signal (HDMI 1, 2 connectors)	10 to 13*, 26, 32, 37, 45, 47, 50, 55

* Some digital signals input from computers may be displayed as preset memory number of Component or Video GBR signal.

Input Signals and Adjustable/Setting Items

The items in the menus available to adjust differ depending on the input signal. The following tables indicate them.

The items that cannot be adjusted are not displayed in the menu.

Picture menu

Item	Input signal		
	Component signal	Video GBR signal	Computer signal
Advanced Iris	●	●	●
Lamp Control	●	●	●
Film Projection	●	●	–
Motion Enhancer	●	●	–
Contrast	●	●	●
Brightness	●	●	●
Color	●	●	–
Hue	●	●	–
Color Temp.	●	●	●
Sharpness	●	●	–
NR	● (preset memory numbers 3, 4, 7, 8, 9 only)	● (preset memory numbers 3, 4, 7, 8, 9 only)	–
MPEG NR	●	●	●
Film Mode	● (excluding preset memory number 14)	● (excluding preset memory number 14)	–
Black Level Adj.* ¹	●	●	–
White Level Adj.* ¹	●	●	–
Gamma Correction * ¹	●	●	●
x.v.Color	●	–	–
Color Space	●	●	●
RCP	●	●	●

● : Adjustable/can be set

– : Not adjustable/cannot be set

Screen menu

Item	Input signal		
	Component signal	Video GBR signal	Computer signal
Wide Mode	●	●	● *3
Over Scan	●	●	—
Screen Area *2	● (preset memory numbers 7, 8, 9, 12, 13, 14 only)	● (preset memory numbers 7, 8, 9, 12, 13, 14 only)	—
V Center *4	●	●	●
Vertical Size *4	●	●	—
APA	—	—	● *5
Phase	—	—	● *5
Pitch	—	—	● *5
Shift	● *5	● *5	●

● : Adjustable/can be set

— : Not adjustable/cannot be set

*1: The setting can be made only when “x.v.Color” is set to “Off.”



*2: The setting can be made only when “Wide Mode” is set to “Full” and “Over Scan” is set to “On” on the Screen  menu.

*3: If the input signal is from a computer, the setting cannot be made when the aspect ratio is 16:9 or wider (fixed at “Full 1”).

*4: The setting can be made only when “Zoom” is selected in “Wide Mode.”

*5: The setting can be made only for analog signal.

Note

When connecting a cable such as an HDMI cable, etc., check the type of the signal in the Information  menu ( page 66) and Digital signal ( page 84), and check items that are adjustable/can be set.

Compatible 3D Signals

The projector accepts the following types of 3D signals.

Resolution	3D signal format
720/60, 50P	Side-by-Side format
	Over-Under format*
	Frame packing*
1080/60, 50i	Side-by-Side format*
1080/24P	Over-Under format*
	Frame packing*
1080/60, 50P	Side-by-Side format
	Over-Under format

*: Mandatory 3D format of the HDMI standards.

3D Signals and Adjustable/Setting Items

Some items on the menus may not be available to adjust/set, depending on the 3D signals. The items that cannot be adjusted are not displayed on the menu. The following tables indicate those items.

Item	3D signals			
	720/60, 50P	1080/60, 50i	1080/24P	1080/60, 50P
Advanced Iris	–	–	–	–
Lamp Control	– (fixed at “High”)	– (fixed at “High”)	– (fixed at “High”)	– (fixed at “High”)
Film Projection* ¹	–	–	–	–
Motion enhancer	–	–	●	–
NR	–	–	–	–
MPEG NR	●	●	– * ²	●
Film mode	–	–	–	–
x.v.Color	–	–	● (component signal only)	–
Wide mode	– (fixed at “Full”)	– (fixed at “Full”)	– (fixed at “Full”)	– (fixed at “Full”)
Over scan	–	–	–	–
Screen area	– (fixed at “Full”)	– (fixed at “Full”)	– (fixed at “Full”)	– (fixed at “Full”)
V keystone	– (fixed at “0”)	– (fixed at “0”)	● (fixed at “0”)	– (fixed at “0”)

- : Adjustable/can be set
- : Not Adjustable/cannot be set
- *1: The setting can be made for 2D display
- *2: The setting can be made for Over-Under format

When the projector is set to convert 2D video images to 3D video images, some items on the menus may be not available to adjust/set, depending on the “3D Format” settings on the Function  menu. The items that cannot be adjusted are not displayed on the menu. The following tables indicate these items.

Item	3D format		
	Side-by-Side	Over-Under	Simulated 3D
Advanced Iris	–	–	–
Lamp Control	–	–	–
Motion enhancer	● (preset memory number 14 only)	–	●
NR	–	–	● (preset memory numbers 7, 8 only)
MPEG NR	●	●	●
Film mode	–	–	–
x.v.Color	● (preset memory number 14 only)	–	●
Wide mode	–	–	–
Over scan	–	–	–
Screen area	–	–	–
V keystone	● (preset memory number 14 only)	–	–

Ceiling Installation

Use the PSS-H10 Projector Suspension Support when you install the projector on a ceiling. The projection distances for ceiling installation are shown below.

- L': Distance between the screen and the installation hole at the ceiling side of the ceiling mount unit (front side)
- y': Distance between the ceiling and the center of the screen such that the picture will not be truncated or blocked

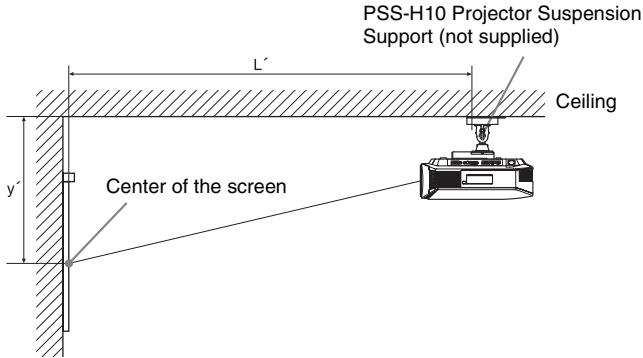

When using the 16:9 aspect ratio screen size

Screen Size SS (inches)		40	60	80	100	120	150	200	250	300
(mm)		1016	1524	2032	2540	3048	3810	5080	6350	7620
L'	(minimum)	1385 (54 ¹⁷ / ₃₂)	2008 (79 ¹ / ₁₆)	2632 (103 ⁵ / ₈)	3256 (128 ⁵ / ₃₂)	3879 (152 ²³ / ₃₂)	4814 (189 ¹⁷ / ₃₂)	6373 (250 ²⁹ / ₃₂)	7932 (312 ⁹ / ₃₂)	9491 (373 ²¹ / ₃₂)
	(maximum)	2013 (79 ⁹ / ₃₂)	2955 (116 ⁵ / ₁₆)	3896 (153 ³ / ₈)	4837 (190 ⁷ / ₁₆)	5779 (227 ¹ / ₂)	7190 (283 ³ / ₃₂)	9544 (375 ³ / ₄)	11897 (468 ³ / ₈)	14250 (561 ¹ / ₃₂)
y'	(minimum)	249 (9 ⁷ / ₈)	374 (14 ³ / ₄)	498 (19 ⁵ / ₈)	623 (24 ⁵ / ₈)	747 (29 ¹ / ₂)	934 (36 ⁷ / ₈)	1245 (49 ¹ / ₈)	1557 (61 ³ / ₈)	1868 (73 ⁵ / ₈)
	(maximum)	592 (23 ³ / ₈)	754 (29 ³ / ₄)	916 (36 ¹ / ₈)	1078 (42 ¹ / ₂)	1240 (48 ⁷ / ₈)	1483 (58 ¹ / ₂)	1887 (74 ³ / ₈)	2292 (90 ¹ / ₄)	2697 (106 ¹ / ₄)

Unit: mm (inches)

To calculate the installation positions

$$L' \text{ (minimum)} = 31.1781 (1 \frac{7}{32}) \times SS + 137.7 (5 \frac{13}{32})$$

$$L' \text{ (maximum)} = 47.0644 (1 \frac{27}{32}) \times SS + 130.8 (5 \frac{5}{32})$$

$$y' \text{ (minimum)} = 6.2263 (\frac{1}{4}) \times SS$$

$$y' \text{ (maximum)} = 8.0942 (\frac{5}{16}) \times SS + 268.5 (10 \frac{9}{16})$$

When using the 4:3 aspect ratio screen size

Screen Size SS (inches)		40	60	80	100	120	150	200	250	300
(mm)		1016	1524	2032	2540	3048	3810	5080	6350	7620
L'	(minimum)	1664 (65 ¹ / ₂)	2427 (95 ⁹ / ₁₆)	3190 (125 ¹⁹ / ₃₂)	3953 (155 ²¹ / ₃₂)	4717 (185 ¹¹ / ₁₆)	5861 (230 ³ / ₄)	7769 (305 ⁷ / ₈)	9677 (380 ³¹ / ₃₂)	11585 (456 ³ / ₃₂)
	(maximum)	2435 (95 ²⁷ / ₃₂)	3587 (141 ⁷ / ₃₂)	4739 (186 ⁹ / ₁₆)	5891 (231 ²⁹ / ₃₂)	7043 (277 ⁹ / ₃₂)	8771 (345 ⁵ / ₁₆)	11651 (458 ¹¹ / ₁₆)	14531 (572 ¹ / ₁₆)	17411 (685 ¹⁵ / ₃₂)
y'	(minimum)	305 (12 ¹ / ₈)	457 (18)	610 (24 ¹ / ₈)	762 (30)	914 (36)	1143 (45)	1524 (60)	1905 (75)	2286 (90)
	(maximum)	665 (26 ¹ / ₄)	863 (34)	1061 (41 ⁷ / ₈)	1259 (49 ⁵ / ₈)	1457 (57 ³ / ₈)	1754 (69 ¹ / ₈)	2250 (88 ⁵ / ₈)	2745 (108 ¹ / ₈)	3240 (127 ⁵ / ₈)

Unit: mm (inches)

To calculate the installation positions

$$L' \text{ (minimum)} = 38.1569 (1 \frac{1}{2}) \times SS + 137.7 (5 \frac{13}{32})$$

$$L' \text{ (maximum)} = 57.5992 (2 \frac{9}{32}) \times SS + 130.8 (5 \frac{5}{32})$$

$$y' \text{ (minimum)} = 7.62 (\frac{5}{16}) \times SS$$

$$y' \text{ (maximum)} = 9.906 (\frac{3}{8}) \times SS + 268.5 (10 \frac{9}{16})$$

Attaching the PSS-H10 projector suspension support

For details on installation on a ceiling, refer to the Installation manual for Dealers of the PSS-H10. Make sure to consult with a qualified Sony personnel for installation. The installation measurements are shown below when installing the projector on a ceiling using the PSS-H10.

Top view

Install the projector so that the center of the lens is parallel to the center of the screen.

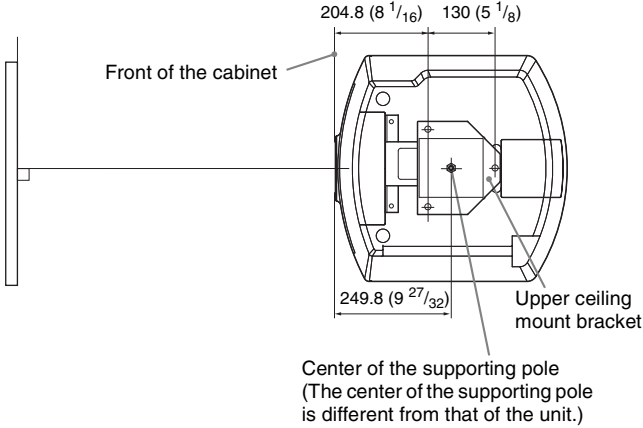

Front view

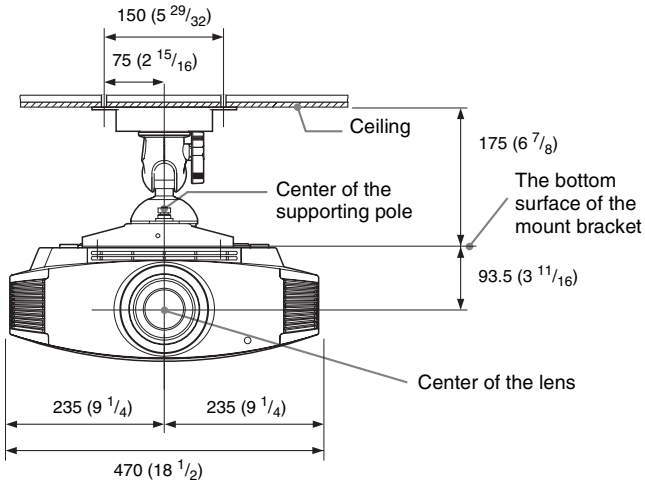

Side view

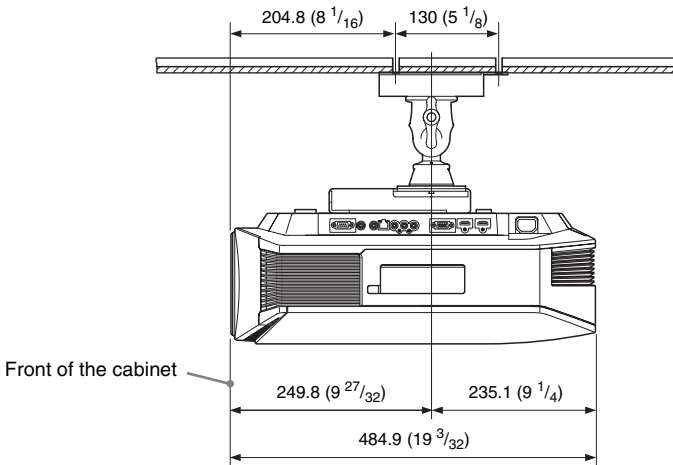

Index

Numerics

3D Glasses	
3D glasses communication range	39
Using the 3D Glasses	39
3D Settings	
2D-3D Display Sel.	60
3D Depth Adjust	61
3D Format	60
3D Glasses Bri'ght	61
Simulated 3D Effect	61

A

Acceptable 3D Signals	87
Adjust Signal	
APA	57
Phase	57
Pitch	57
Shift	57
Adjuster	24
Adjusting	
picture position	20
picture quality	42
Advanced Iris	50
APA	57
Auto Input Search	62

B

Background	62
Black Level Adj.	52
Blanking	64
Brightness	51

C

Ceiling Installation	89
Cinema Black Pro	50
Color Space	53
Color Temp.	51
Connecting	
Computer	27
Connecting to an Optional TMR-PJ1 3D Sync Transmitter	28
Video equipment	25
Contrast	50
Control for HDMI	61
Cooling Setting	58

E

Expert Setting	51
----------------	----

F

fH	66
Film Projection	50
fV	66

G

Gamma Correction	52
------------------	----

H

HDMI	25
Hue	51

I

Image Flip	63
ImageDirector3	44, 53
Input-A Signal Sel.	59
IR Receiver	64

L

Lamp Control	50
Lamp Timer	66
Language	58
Lens Control	63
Location of Controls	
Front/Right side	8
Rear/Bottom	9

M

Menu	
Advanced Picture	54
Function	60
Information	66
Installation	63
Picture	49
Screen	55
Setup	58
Messages	
Caution	74
Warning	73
Motion Enhancer	50
Motionflow	50
MPEG NR	51

N

NR	51
----	----

O

Over Scan 56

P

Panel Alignment 65

Picture Mode

 CINEMA 41

 Cinema 49

 DYNAMIC 41

 Dynamic 49

 GAME 41

 Game 49

 PHOTO 41

 Photo 49

 STANDARD 41

 Standard 49

 USER 41

 User 49

Picture Position

 Using the Picture Position 33

Precautions 7

Preset Memory 66

Preset Signals 83

R

RCP 54

Remote control

 inserting the batteries 11

 location of controls 10

Reset

 resettable items 48

 resetting the items 48

S

Screen Area 56

Selecting the menu language 29

Sharpness 51

Specifications 81

Standby Mode 58

Status 58

Supplied accessories 11

T

Test Pattern 62

Trigger Select 63

Troubleshooting 69

V

V Keystone 63

W

White Level Adj. 52

WIDE MODE 34

Wide Mode

 Anamorphic Zoom 56

 Full 56

 Full 1 56

 Full 2 56

 Normal 56

 Wide Zoom 56

 Zoom 56

X

x.v.Color 53

